



60/30 CLASSIC

01.01.2024



60/30 CLASSIC STEEL SHELVING

The 60/30 Classic Steel Shelving system is the essence of many years of experience and success. This flexible product concept has evolved over the years and the modular structure and the large number of standard components ensure ideal room utilization and rational accommodation of all relevant functions. In addition the flexibility of the system allows a variety of individual solutions which our design teams bring to life for the individual library.

You will find all our standard products in this overview. For additional inspiration we invite you to visit our website, where you can find project inspiration from our latest projects around the world.

The 60/30 Classic Steel Shelving system is shown in many creative configurations mixed with special developments such as round shelving with seating benches and castors, integrated youth corners with tables and chairs etc. Our broad portfolio of library furniture provides endless possibilities. Please contact our professional sales teams for inspiration.



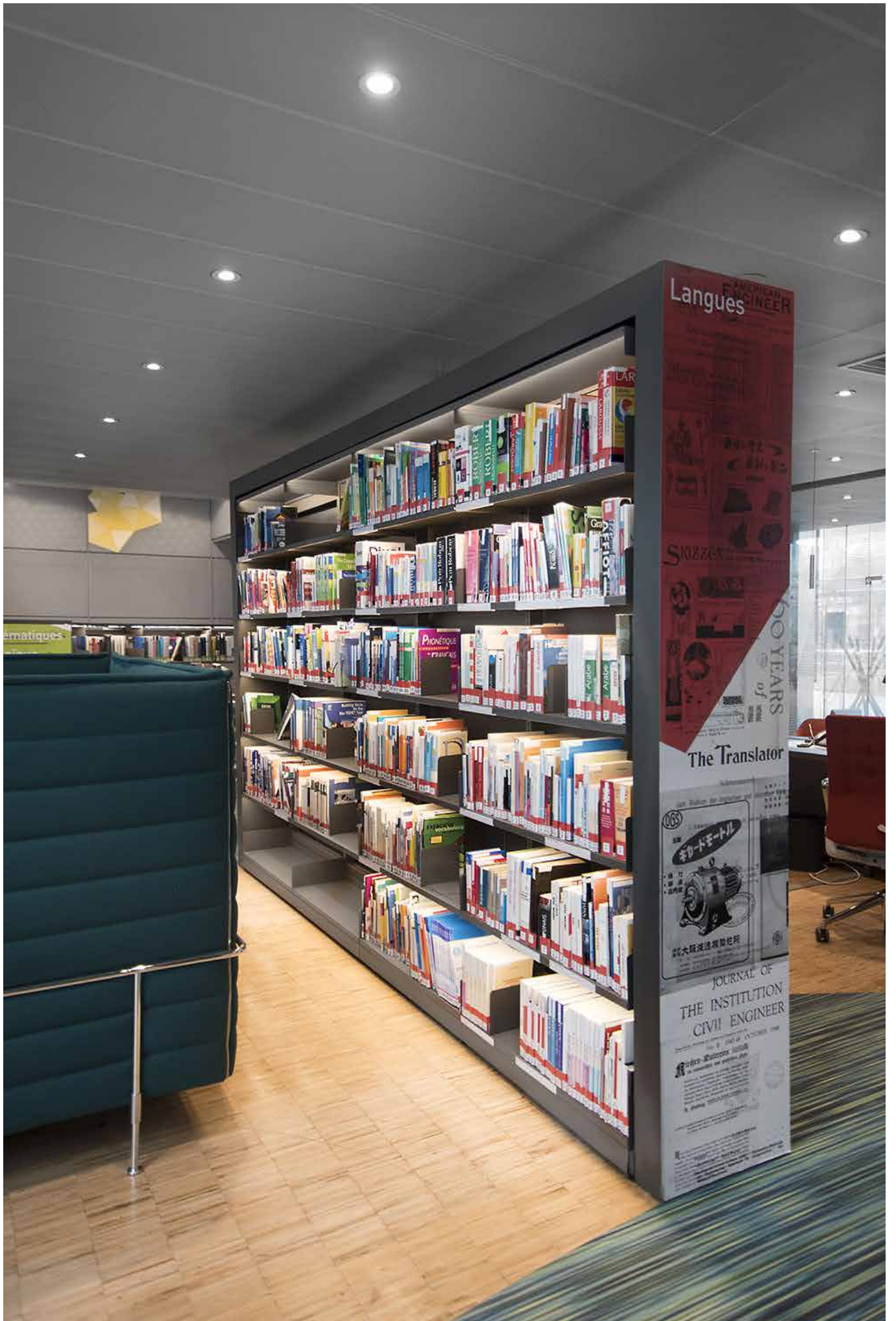

INDEX

FSC	6
DESIGN OPTIONS	9
TECHNICAL SPECIFICATIONS	12
DIMENSIONS	16

STRAIGHT CONFIGURATIONS

60/30 CLASSIC STEEL SHELVING	26
Single-sided configurations without shelves	28
Double-sided configurations without shelves	30
Single-sided configurations without top shelf	32
Double-sided configurations without top shelf	34
Single-sided configurations with top shelf	36
Double-sided configurations with top shelf	38
60/30 CLASSIC STEEL SHELVING WITH LED	40
Single-sided configurations without top shelf	42
Double-sided configurations without top shelf	44
Single-sided configurations with top shelf	46
Double-sided configurations with top shelf	48
80/30 CLASSIC STEEL SHELVING	50
Single-sided configurations	52
Double-sided configurations	53
60/30 CLASSIC STEEL SHELVING - WALL	54
Single-sided configurations	56
60/30 EXPO	58
Double-sided configurations - H122 cm	60
Double-sided configurations - H152 cm	63

COMPONENTS FOR STRAIGHT SHELVING

SHELVES	
Steel shelves	66
Steel top shelves and London top plates	74
Wooden shelves	102
Wooden top shelves and London top plates	104
Accessories for shelves	113
ACCESSORIES	
Book supports	114
Browsers	116
Display & storage - magazines	121
Display & storage - multimedia	125
Display & storage - for shelves	126
Display & storage - for slat end panels	128
Display & storage - for perforated end panels	129
Signage - for end panels/uprights/tops	131
Signage - for shelves	132
UPRIGHTS & CROSSBARS	
Uprights for 60/30 Classic	134
Uprights for 80/30 Classic	135
Wall strips for 60/30 Classic	136
Uprights, frame and castor set for hidden castors	137
Upright extensions & crossbars	138
CASTORS & PLINTHS	
Plinths & castors	139
PANELS	
Wooden end panels	140
Wooden slat end panels	142
Wooden London end panel	144
Perforated steel end panels	146
Steel London end panels	147
Glass end panels	148
Back panels	149
END PANEL BAYS	
End panel bay with adjustable feet	152
End panel bay with adjustable feet and London top	154
End panel bay with castors	156
End panel bay with castors and London top	157
Steel shelves for end panel bays	158
LIGHTING	
LED lighting	160
Book LED lighting	162

DKK

ROUND CONFIGURATIONS

60/30 ROUND STEEL SHELVING	164
Double-sided configurations without shelves	165
Double-sided configurations without top shelf	166
Double-sided configurations with top shelf	167

COMPONENTS FOR ROUND SHELVING

SHELVES

Steel shelves	168
Steel top shelves	170
Wooden London top plates	176
Components for shelves	177

UPRIGHTS & CROSSBARS

Uprights for 60/30 Classic Round	178
Crossbars	178

CASTORS & PLINTHS

Plinths & castors	179
-------------------------	-----

PANELS

Wooden end panels	181
Wooden slat end panels	182
Wooden London end panels	183
Perforated steel end panels	184

END PANEL BAYS

End panel bay with adjustable feet	188
End panel bay with adjustable feet and London top	190
End panel bay with castors	192
End panel bay with castors and London top	193
Steel shelves for end panel bays	194



WOOD FROM SUSTAINABLE MANAGED FORESTRY

We are committed to increasing the share of sustainable raw wooden material in our products and thereby support responsibly managed forests – for a better world.

Governments and local authorities are specifying the supply of legal and responsibly sourced wood in their procurement policies.

We have invested in a Chain-of-Custody Multi-site certificate (FSC-C 144988), issued by FSC®, which documents, that we can offer wood from responsibly managed forests. FSC (Forest Stewardship Council) is an international labelling scheme, that documents that FSC labelled products originate from sustainable forestry.

Working with certified suppliers, we can now offer all painted and veneered components as fully FSC Mix certified (noted in this document for each wooden product, which is FSC-certified).



What is sustainable managed forestry?

According to the FSC, forests, managed according to their principles and criteria, mean fair conditions for workers, respect for indigenous communities and local populations as well as strict environmental controls.

The FSC label guarantees that the trees that are harvested are replaced or allowed to regenerate naturally.

The FSC label also guarantees that all the wood is tracked from the forest to the store. Every link between the forest and the consumer is certified to make it clearly identifiable which wood is from sustainable forestry and which is not.

Source: Forest Stewardship Council
<http://www.fsc-uk.org/en-uk>





DESIGN OPTIONS

STEEL COMPONENTS - PAINTED

A PRICE GROUP - BASIS PRICE (smooth finish)



A03
Traffic white
RAL 9016
Gloss 75-90



A02
Oyster white
RAL 1013
Gloss 40-50

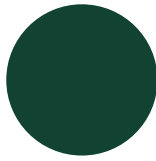

A22
Moss green
RAL 6005
Gloss 71-85

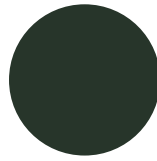

A26
Fir green
RAL 6009
Gloss 71-85

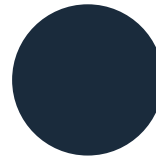

A12
Steel blue
RAL 5011
Gloss 71-85

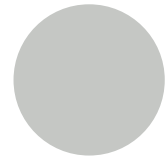

A13
Light grey
RAL 7035
Gloss 71-85

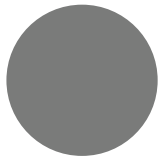

A15
Dusty grey
RAL 7037
Gloss 71-85

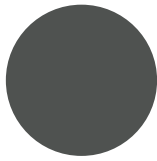

A16
Traffic grey
RAL 7043
Gloss 71-85

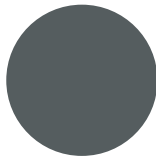

A17
Basalt grey
RAL 7012
Gloss 71-85

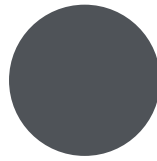

A18
Slate grey
RAL 7015
Gloss 71-85

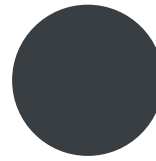

A19
Anthracite grey
RAL 7016
Gloss 71-85

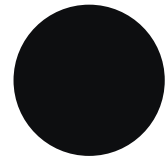

A25
Jet black
RAL 9005
Gloss 71-85

B PRICE GROUP - BASIS PRICE WITH 7% SURCHARGE (smooth finish)



A01
Pure white
RAL 9010
Gloss 71-85

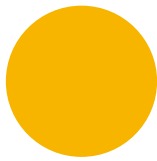

A04
Traffic yellow
RAL 1023
Gloss 71-85

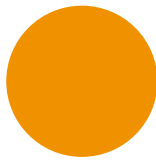

A05
Sun yellow
RAL 1037
Gloss 71-85

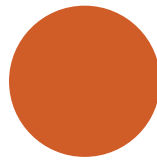

A06
Signal orange
RAL 2010
Gloss 71-85

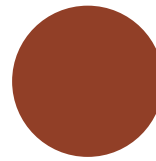

A07
Pearl orange
RAL 2013
Gloss 65-85

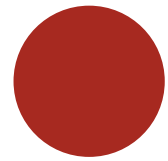

A08
Flame red
RAL 3000
Gloss 71-85

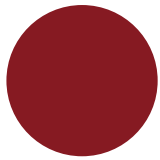

A09
Ruby red
RAL 3003
Gloss 71-85



A21
Reseda green
RAL 6011
Gloss 71-85

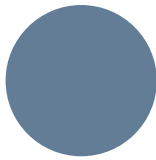

A10
Pigeon blue
RAL 5014
Gloss 71-85

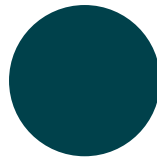

A11
Ocean blue
RAL 5020
Gloss 71-85

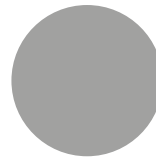

A14
White aluminium
RAL 9006
Gloss 50-70

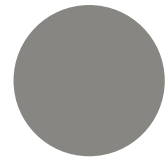

A31
Grey aluminium
RAL 9007
Gloss 50-70

B PRICE GROUP - BASIS PRICE WITH 7% SURCHARGE (textured finish)



A27
Pure white
RAL 9010

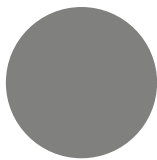

A29
Concertina grey

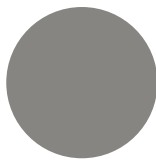

A28
Grey aluminium
RAL 9007

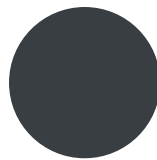

A23
Anthracite grey
RAL 7016

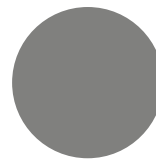

A24
Graphite black
RAL 9011

Note:

- Other RAL/NCS colours have a starter fee of GBP 215 / EUR 250 and a surcharge of 15%. A higher surcharge for colours with "metallic" look or different surface textures must be expected.
- See specific colour for steel gloss specification. Special requests outside specified gloss range are not covered by the above surcharges.
- Chrome, electro galvanised and aluminium parts are not available in other colours.
- Products such as e.g. castors and accurides cannot be produced in other colours than described in the price list.

DESIGN OPTIONS

WOODEN COMPONENTS - PAINTED

A PRICE GROUP - BASIS PRICE

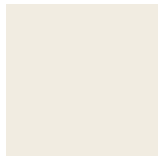

A01
Pure white
RAL 9010
Gloss 20-30



A02
Oyster white
RAL 1013
Gloss 20-30

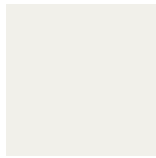

A03
Traffic white
RAL 9016
Gloss 20-30



A04
Traffic yellow
RAL 1023
Gloss 20-30



A05
Sun yellow
RAL 1037
Gloss 20-30



A06
Signal orange
RAL 2010
Gloss 20-30



A07
Pearl orange
RAL 2013
Gloss 20-30



A08
Flame red
RAL 3000
Gloss 20-30



A09
Ruby red
RAL 3003
Gloss 20-30



A21
Reseda green
RAL 6011
Gloss 20-30



A22
Moss green
RAL 6005
Gloss 20-30



A26
Fir green
RAL 6009
Gloss 20-30



A10
Pigeon blue
RAL 5014
Gloss 20-30



A11
Ocean blue
RAL 5020
Gloss 20-30



A12
Steel blue
RAL 5011
Gloss 20-30



A13
Light grey
RAL 7035
Gloss 20-30



A14
White aluminium
RAL 9006
Gloss 20-30



A31
Grey aluminium
RAL 9007
Gloss 20-30



A15
Dusty grey
RAL 7037
Gloss 20-30



A16
Traffic grey
RAL 7043
Gloss 20-30



A17
Basalt grey
RAL 7012
Gloss 20-30



A18
Slate grey
RAL 7015
Gloss 20-30



A19
Anthracite grey
RAL 7016
Gloss 20-30



A25
Jet black
RAL 9005
Gloss 20-30

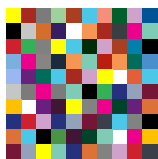

Any RAL/NCS colour
Gloss 20-30

Note:

- The above selection of colours match our steel colours. Note that you can order any RAL/NCS colour without surcharge.
- A surcharge for colours with "metallic" look or different surface textures must be expected, please contact Customer Service.

DESIGN OPTIONS

WOODEN COMPONENTS - VENEER

A PRICE GROUP - BASIS PRICE



55
Light steamed
beech



66
Oak



67
Maple



68
Ash



69
Birch

Note:

- The wooden veneers can also be stained for a surcharge, please contact Customer Service. Samples will be forwarded for approval.

TECHNICAL SPECIFICATIONS

GENERAL SPECIFICATIONS

DIMENSIONS

Dimensions of complete bays in available modules and heights can be found in each catalogue section which include complete configurations. See index page for overview.

MOUNTING TOLERANCES

The tolerances of the increments of the column limit the number of shelving bays, which can be built together. Generally the tolerances permit up to 10 successive bays. Above 10 bays it is advised to continue with a starter bay.

MAXIMUM LOAD

Steel top shelf - max. load of 25 kg.

Steel shelf with backedge - max. load of 80 kg.

Round steel top shelf - max. load of 25 kg.

Round steel shelf with backedge - max. load of 30 kg.

Round steel shelf with backedge and shelf strengthener - max. load of 80 kg.

Wooden top shelf - particleboard - max. load of 25 kg.

Wooden shelf with backedge - block board - max. load of 80 kg.

Steel browser with pull-out frame - max. load of 40 kg

MOBILE SHELVINGS/CASTORS

Only double-sided shelving units with a max. height of 152 cm and maximum 3 bays can be mounted with castors. Castors are available with or without brakes. Max. load of 120 kg per castor, max. load of 100 kg per hidden castor.

EXTENSIONS FOR UPRIGHTS

are used to increase the capacity. Enables an extra layer of shelves. Available for single- and double-sided uprights. Can be used for uprights of max. height of 229 cm.

STABILITY

All uprights are provided with adjustable feet that can be adjusted even when the system is loaded. Single-sided uprights are supplied with anti-topple brackets.

ROUNDED EDGES

All storage units and brackets have rounded edges.

BROWSERS

It is important to remember the following, when installing browsers in a shelving system:

- Browsers without tubes are meant for low medias with a maximum height of 20 cm, meaning they are not suited for e.g. picture books, as they may tip over the edge. If you wish to use store/display tall medias in browsers, then it is recommended to use single browsers with tubes, 20 cm in height and to place the books as far back as possible.
- The foot of the upright must minimally be the same depth as the browser, meaning that a 30 cm deep browser must only be installed on a 30 or 40 cm deep upright and a 40 cm deep browser on a 40 cm deep upright.
- We recommend that all shelving systems with browsers are either fixed to the floor or wall.
- Ensure that children do not play/crawl/hang on the shelving system.
- The maximum weight for each pull-out browser is 45 kg.

ASSEMBLY

No special fittings or tools are needed.

TECHNICAL SPECIFICATIONS

STEEL COMPONENTS

STEEL COMPONENTS

are powder coated with standard polyester based powders that secures high UV resistance. Powders comply with EN 45545 (fire protection - similar to DIN 4201). Thickness of the coating is 60-80 my. The powder used includes no triglycidylisocyanurate (TGIC), no heavy metal-containing pigments such as lead and cadmium and no volatiles

Steel components are not treated with any biocidal products.

Antibacterial equipping of surfaces upon request.

STEEL UPRIGHTS

are made of steel square tubes. The freestanding single- and double-faced uprights are available in two strengths which are recommended based on load carrying requirements. Choose between configurations with either 60 x 30 mm or 80 x 30 mm external dimensions. The upright is 2 mm thick and the welded foot is 3 mm thick. The uprights allow a wide range of shelves and other functions to be mounted in a row of punched holes with a distance of 25 mm. The uprights are provided with plastic caps to close the tube ends. The uprights are also provided with adjustable feet, adjustable to a max. of 25 mm.

STEEL WALL STRIPS

are made of 2 mm steel coils. The uprights allow a wide range of shelves and other functions to be mounted in a row of punched holes with a distance of 25 mm.

STEEL CROSSBARS

are made of 1.4 mm sheet steel. The crossbars are with hooks for easy connection to uprights. The uprights are connected with 2 crossbars for each bay. The top and bottom crossbar have an opening/groove to allow back panels to be fitted to the uprights without the use of special fittings or tools. A third crossbar is used on first and every third 229 and 259 cm high shelving bay. For heavy load it is recommended to use 3 crossbars in each bay. The third crossbar will be mounted at a fixed position using the slots at height 98 cm above the floor.

STEEL CROSSBARS FOR ROUND SHELVING

are made of 20 x 70 x 2 mm steel square tubes. The crossbars are with connection fittings for easy connection to uprights. The uprights are connected with 2 crossbars for each bay.

STEEL BRACKETS

are made of 1.4 mm sheet steel.

STEEL SHELVES/BROWSERS/CABINETS/PULL-OUT SHELVES

are made of 0.9 mm sheet steel. The flat steel shelves have a 25 mm high front edge. The sloping steel shelves are bent in a way so they have a stopper to prevent magazines from sliding off. Flat steel shelves can be mounted in a sloping position by changing brackets.

STEEL PLINTHS

are 60 mm high and made of 0.9 mm sheet steel.

LONDON STEEL PLINTHS

are made of 0.9 mm sheet steel over 1 and 2 bays and 1.5 mm sheet steel over 3 bays.

PERFORATED STEEL END PANELS

are made of 1.4 mm sheet steel. The perforations are Ø4.5 mm.

LONDON STEEL END PANELS AND TOPS

are made of 1.4 mm sheet steel with a 30 mm wide front edge.

TECHNICAL SPECIFICATIONS

WOODEN COMPONENTS

DENSITY

Particle board has a density of 600-700 kg/m³

Block board has a density of 602 m³ (+/- 2 %)

MDF has a density of 700 kg/m³ (+/- 5-7 %)

PAINTED WOODEN COMPONENTS

are made of MDF (medium density fibre board) which is painted with acid lacquer. Standard components have gloss 20 - 30, except for shelves for Expo that have gloss 60 - 70.

PAINTED PANELS

are made of 19 mm MDF. The wooden panels are supplied with fittings and hooks for easy connection to uprights.

PAINTED DISPLAY PANELS

are made of 22 mm MDF. The wooden panels are supplied with fittings with hooks for easy connection to uprights.

PAINTED LONDON WOODEN PANELS AND TOPS

are made of 30 mm MDF. Along the vertical edges of the panel a flat aluminium profile is attached. The aluminium profile is powder coated in the specified colour. The profiles are mounted on the front edge of panels using visible euro screws which are powder coated in the specified colour. The end panels and top are attached to the shelving using steel brackets.

PAINTED BACK PANELS

are made of 12 mm MDF.

PAINTED TOP SHELVES

are made of 22 mm MDF.

PAINTED SHELVES EXPO

are made of 22 mm MDF with special PU paint to increase robustness.

VENEERED WOODEN COMPONENTS

are mainly lacquered with UV-lacquer.

VENEERED PANELS

are made of 19 mm particleboard and are veneered with 0.6 mm veneer. All vertical and horizontal edges have a 2 mm veneer edge. The wooden panels are supplied with fittings and hooks for easy connection to uprights.

VENEERED DISPLAY PANELS

are made of 22 mm MDF and are veneered with 0.6 mm veneer. All vertical and horizontal edges have a 2 mm veneer edge. The wooden panels are supplied with fittings with hooks for easy connection to uprights.

VENEERED BACK PANELS

are made of 12 mm particleboard and are veneered with 0.6 mm veneer.

VENEERED SHELVES

are made of 22 mm block board and are veneered with 0.6 mm veneer. The front and back edges have a 2 mm veneer edge.

VENEERED TOP SHELVES

are made of 22 mm particleboard and are veneered with 0.6 mm veneer. The front and back edges have a 2 mm veneer edge.

VENEERED CORNER SHELVES

are made of 22 mm particleboard and are veneered with 0.6 mm veneer. The straight edges have a 2 mm veneer edge and the front has a 1 mm wooden edge strip.

TECHNICAL SPECIFICATIONS

GLASS COMPONENTS

GLASS COMPONENTS

GLASS END PANELS

are made of hardened frosted glass. Satimat 10 mm with straight mat facet edges.

DIMENSIONS

60/30 CLASSIC

Please find important dimensions below, configurations can be found on page 26.

HEIGHTS

The shelving system is available in 5 heights; 92, 122, 152, 182 and 212 cm. Heights include adjustable feet (max. 2.5 cm). The shelves are adjustable in 2.5 cm increments.

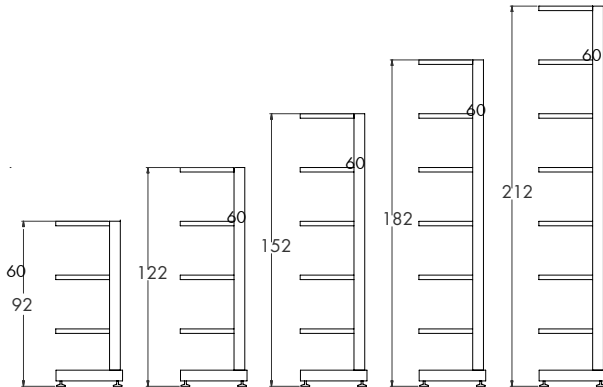

WIDTHS

The bays are available as starter and add-on bays. A starter bay has two uprights and an add-on bay has one upright.

78 cm is shown as module 75 in price list
 93 cm is shown as module 90 in price list
 103.5 is shown as module 100 in price list*

Module 75, 90 and 100 indicate distance from centre to centre of uprights.

*The exact measure of module 100 is 100.5 cm

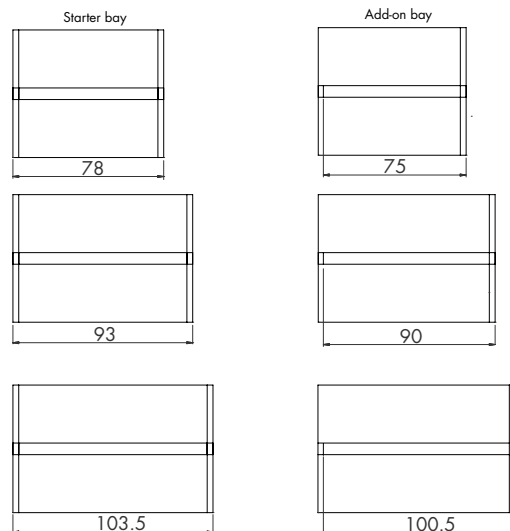

DEPTHS

The uprights are available in 4 depths:

- 30 cm for 22.5 cm deep shelves
- 32 cm for 25 cm deep shelves
- 37 cm for 30 cm deep shelves
- 47 cm for 40 cm deep shelves

- 51 cm for 2 x 22.5 cm deep shelves
- 56 cm for 2 x 25 cm deep shelves
- 66 cm for 2 x 30 cm deep shelves
- 86 cm for 2 x 40 cm deep shelves

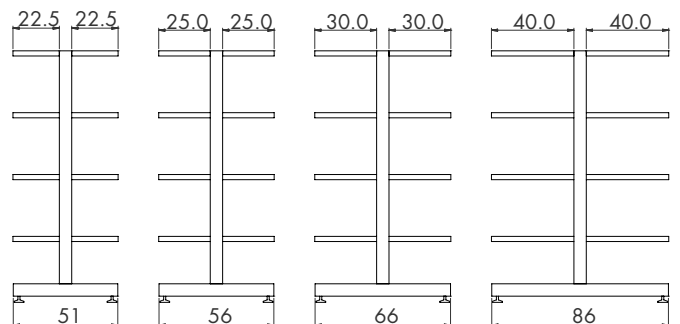
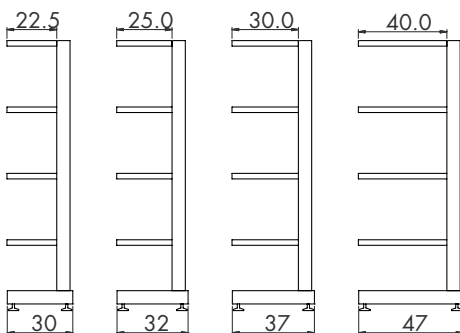

DIMENSIONS

80/30 CLASSIC

Please find important dimensions below, configurations can be found on page 50.

HEIGHTS

80/30 Classic Steel shelving system comes in 3 heights; 199, 229 and 259 cm. Heights include adjustable feet (max. 2.5 cm). The shelves are adjustable in 2.5 cm increments.

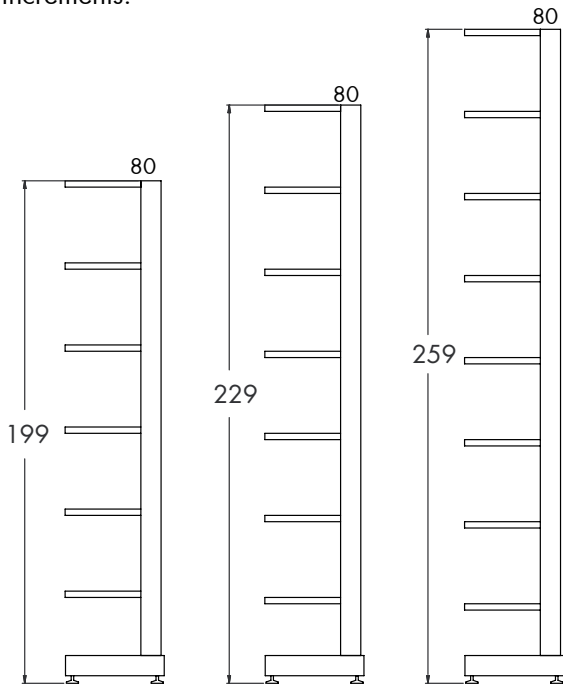

WIDTHS

The bays are available as starter and add-on bays. A starter bay has two uprights and an add-on bay has one upright.

78 cm is shown as module 75 in price list
93 cm is shown as module 90 in price list
103.5 is shown as module 100 in price list*

Module 75, 90 and 100 indicate distance from centre to centre of uprights.

*The exact measure of module 100 is 100.5 cm

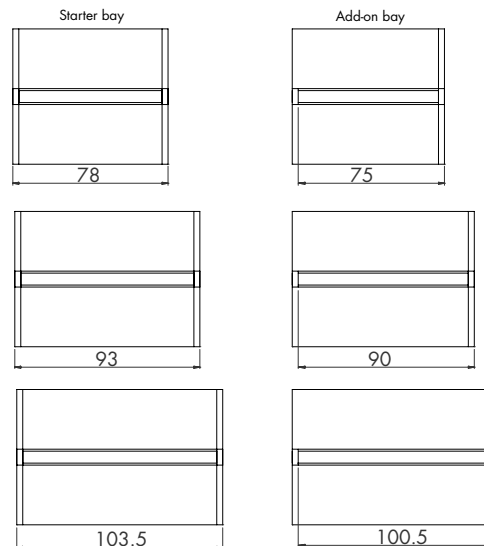

DEPTHS

The uprights come in 4 depths:
32 cm for 22.5 cm deep shelves
34 cm for 25 cm deep shelves
39 cm for 30 cm deep shelves
49 cm for 40 cm deep shelves

53 cm for 2x22.5 cm deep shelves
58 cm for 2x25 cm deep shelves
68 cm for 2x30 cm deep shelves
88 cm for 2x40 cm deep shelves

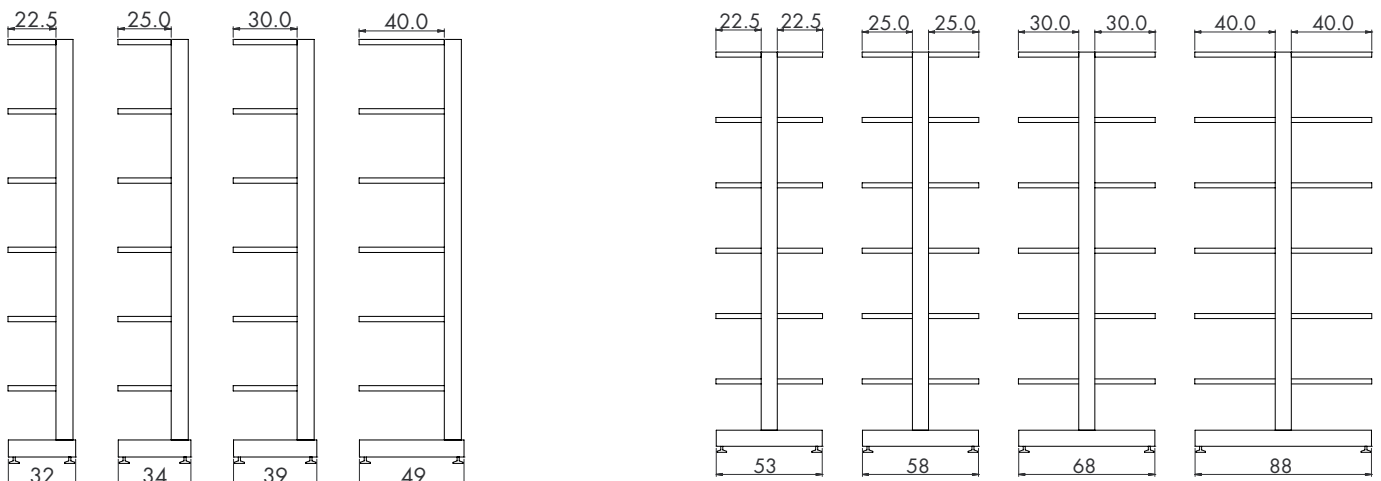

DIMENSIONS

60/30 CLASSIC WALL

Please find important dimensions below, configurations can be found on page 54.

HEIGHTS

60/30 Classic Steel shelving - Wall system comes in 4 heights; 112.5, 142.5, 172.5 and 202.5 cm. The shelves are adjustable in 2.5 cm increments.

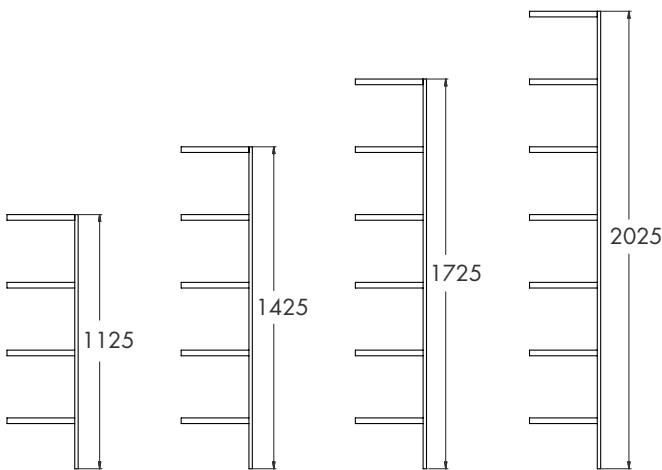

WIDTHS

The bays are available as starter and add-on bays. A starter bay has two wall strips and an add-on bay has one wall strip.

78 cm is shown as module 75 in price list
93 cm is shown as module 90 in price list
103.5 is shown as module 100 in price list*

Module 75, 90 and 100 indicate distance from centre to centre of uprights.

*The exact measure of module 100 is 100.5 cm

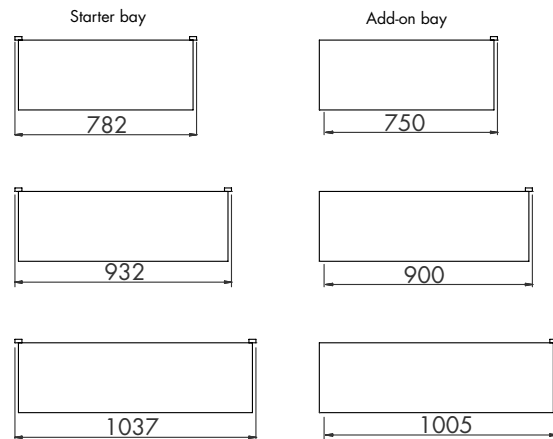

DEPTHS

The uprights come in 4 depths:
24 cm for 22.5 cm deep shelves
26.5 cm for 25 cm deep shelves
31.5 cm for 30 cm deep shelves
41.5 cm for 40 cm deep shelves

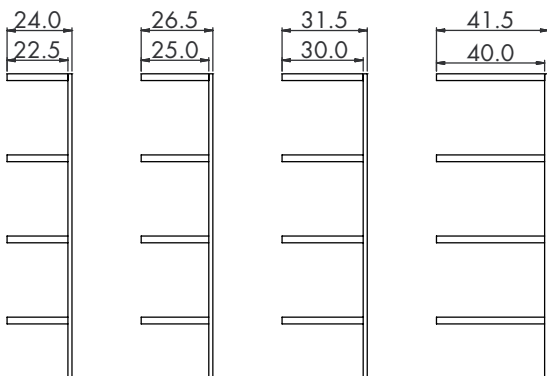

DIMENSIONS

60/30 EXPO

Please find important dimensions below, configurations can be found on page 58.

HEIGHTS

60/30 Expo is available in heights 122 cm and 152 cm. Heights include adjustable feet (max. 2.5 cm). The shelves are adjustable in 2.5 cm increments.

WIDTHS

One bay is 130 cm wide.
Two bays are 220 cm wide.
Three bays are 310 cm wide.

DEPTHS

60/30 Expo is available with a shelf depth of 30 cm.

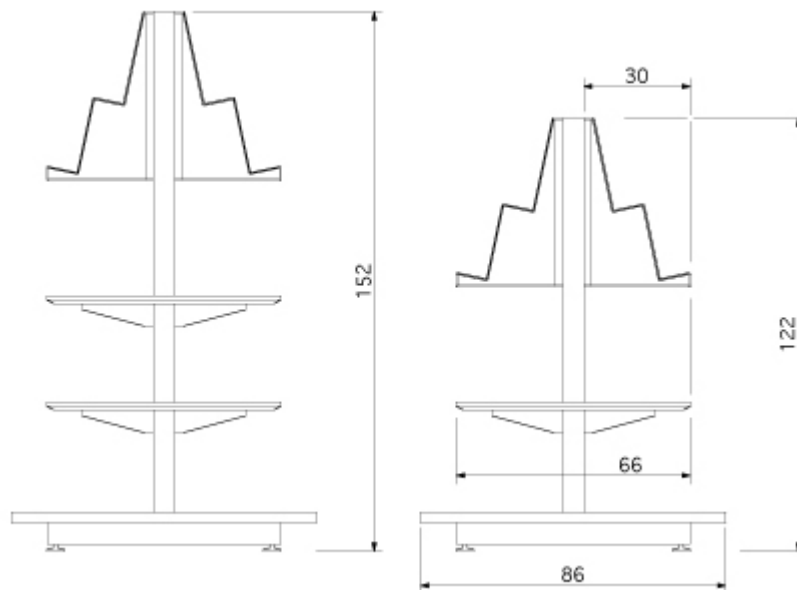

DIMENSIONS

60/30 CLASSIC ROUND

Please find important dimensions below, configurations can be found on page 164.

HEIGHTS

60/30 Classic Round Steel Shelving system is available in 5 heights; 92, 122, 152, 182 and 212 cm. Heights include adjustable feet (max. 2.5 cm). The shelves are adjustable in 2.5 cm increments.

WIDTHS

The bays are available as starter and add-on bays. A starter bay has two uprights and an add-on bay has one upright.

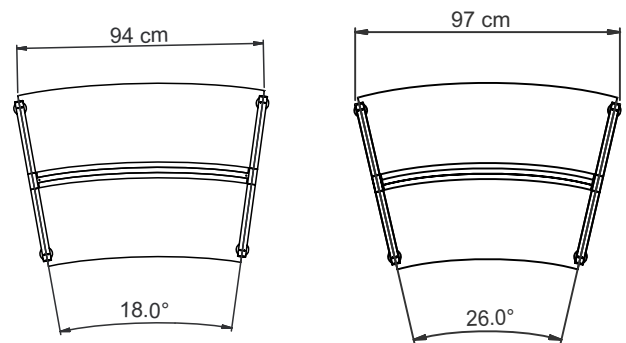
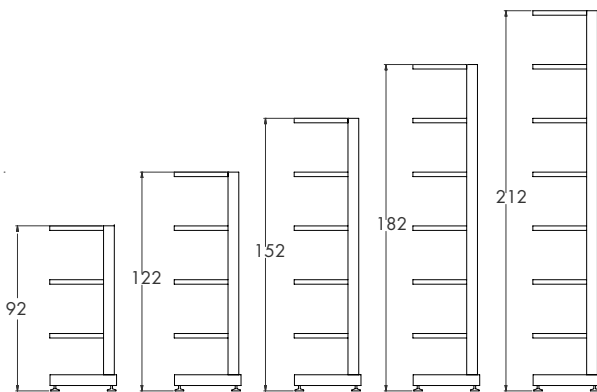

DEPTHS

The uprights come in one depth: 66 cm for 2 x 30 cm deep shelves

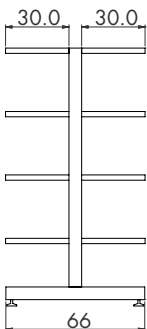

DIMENSIONS

60/30 CLASSIC ROUND

60/30 CLASSIC ROUND 26°

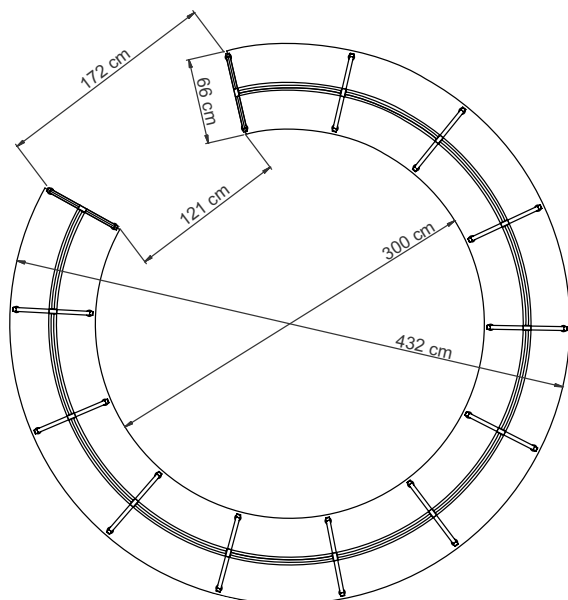

60/30 CLASSIC ROUND 18°

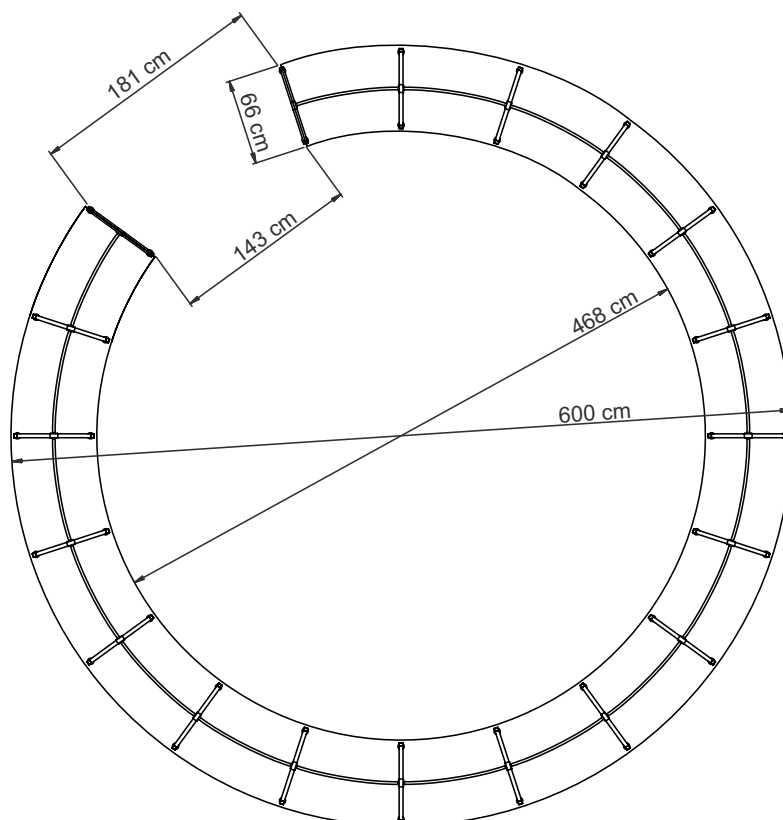

DIMENSIONS

60/30 CLASSIC LONDON TOP PLATE

LONDON WOODEN AND STEEL OVERLAYING TOP PLATES FOR STRAIGHT BAYS

If you build a shelving system with 1, 2 or 3 bays, then you can use just one freestanding top plate.

If you build a shelving system with more than 3 bays, then the overlaying top plates will be a combination of outer and intermediate overlaying top plates.

Freestanding wooden overlaying top plate

Is always used for 1 bay and can be used for 1, 2 or 3 bays. The overlaying top plate covers the end panels in both ends.

Total width mm			
Module	750	900	1000
1 bay	816	966	1071
2 bays	1566	1866	2071
3 bays	2316	2766	3071

Freestanding steel overlaying top plate

Is always used for 1 bay and can be used for up to 2 bays for London Steel. The overlaying top plate fits in between both end panels.

Total width mm			
Module	750	900	1000
1 bay	755	905	1010
2 bays	1505	1805	2010
3 bays	-	-	-

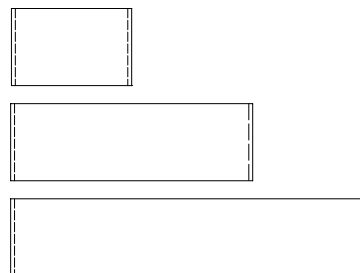

Outer wooden overlaying top plate

Can be used for 1, 2 or 3 bays in combination with either outer or intermediate overlaying top plates. The overlaying top plate covers one end panel.

Total width mm			
Module	750	900	1000
1 bay	783	933	1038
2 bays	1533	1833	2038
3 bays	2283	2733	3038

Outer steel overlaying top plate

Can be used for 1 and 2 bays in combination with either outer or intermediate overlaying top plates. The overlaying top plate is placed in between the end panel and outer/intermediate top plate.

Total width mm			
Module	750	900	1000
1 bay	753	903	1008
2 bays	1503	1803	2008
3 bays	-	-	-

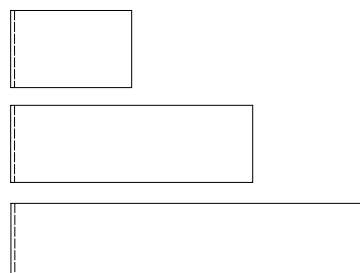

Intermediate wooden overlaying top plate

Can be used for 1, 2 or 3 bays in combination with either outer or intermediate overlaying top plates. The overlaying top plate is placed next to the outer/intermediate overlaying top plate.

Total width mm			
Module	750	900	1000
1 bay	751	901	1006
2 bays	1501	1801	2006
3 bays	2251	2701	3006

Intermediate steel overlaying top plate

Can be used for 1 and 2 bays in combination with either outer or intermediate overlaying top plates. The overlaying top plate is placed next to the outer/intermediate overlaying top plate.

Total width mm			
Module	750	900	1000
1 bay	750	900	1005
2 bays	1500	1800	2005
3 bays	-	-	-

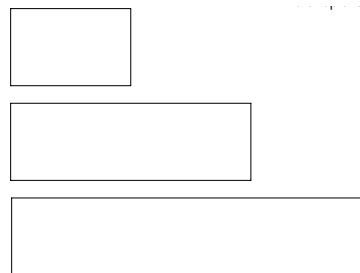

DIMENSIONS

60/30 CLASSIC ROUND LONDON TOP PLATE

LONDON WOODEN OVERLAYING TOP PLATES FOR ROUND BAYS

Use a freestanding or a combination of outer and intermediate wooden London top plates for your shelving system.

Freestanding wooden overlaying top plate

Is always used for 1 bay. The overlaying top plate covers the end panels in both ends.

Dimensions mm				
Bay	26°x	26°y	18°x	18°y
1 bay	1040	724	1006	707

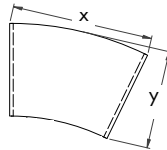

Outer wooden overlaying top plate

Can be used in combination with either outer or intermediate top plates. The overlaying top plate covers one end panel.

Dimensions mm				
Bay	26°x	26°y	18°x	18°y
1 bay	1008	724	974	707

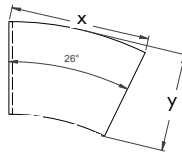

Intermediate wooden overlaying top plate

Can be used in combination with either outer or intermediate top plates. The overlaying top plate is placed next to the outer/intermediate overlaying top plate.

Dimensions mm				
Bay	26°x	26°y	18°x	18°y
1 bay	976	716	941	707

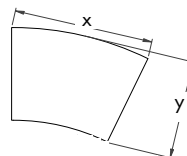

DIMENSIONS

END PANEL BAYS FOR DOUBLE-SIDED 60/30 CLASSIC STEEL SHELVING

Please find important dimensions below, configurations can be found on page 150 and 186.

HEIGHTS

The end panel bays comes in 5 heights for double-sided shelving with/without London wooden top plate. Heights include adjustable feet. The shelves are adjustable in 2.5 cm increments.

For double-sided shelving

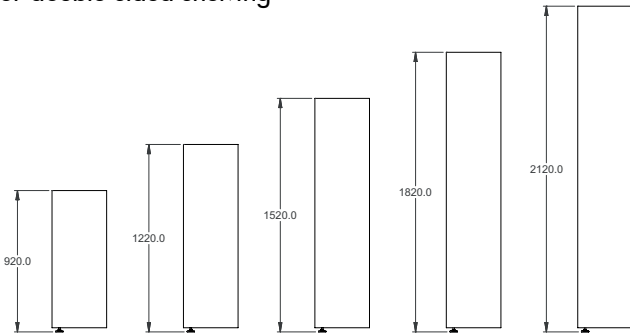

For double-sided shelving with overlaying London wooden top plate

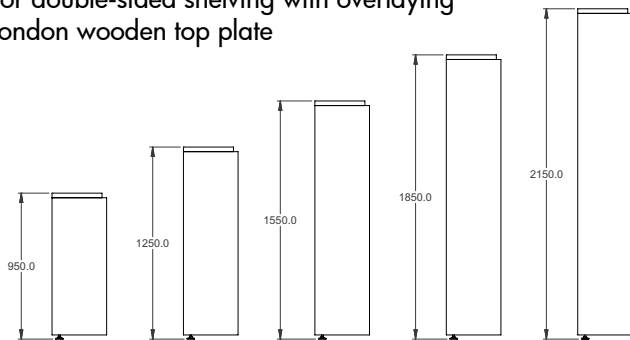

WIDTHS

The width of the end panel bays depend on the depth of the double-sided shelving system they are mounted on:

52,8 cm - for 22,5/22,5 cm shelving

57,8 cm - for 25/25 cm shelving

67,8 cm - for 30/30 cm shelving

87,8 cm - for 40/40 cm shelving

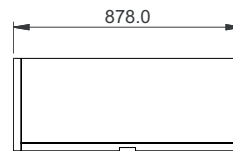
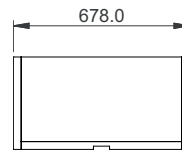
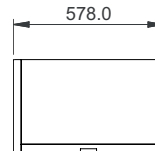
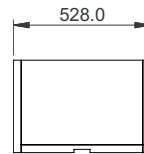

DEPTHS

The end panel bays come in 2 depths:

30,5 cm - for 25 cm deep shelves

35,5 cm - for 30 cm deep shelves

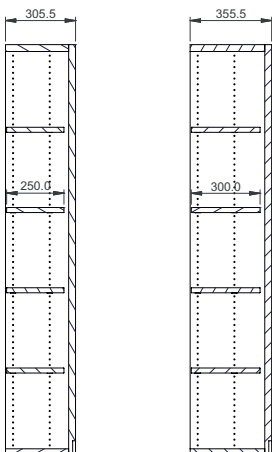



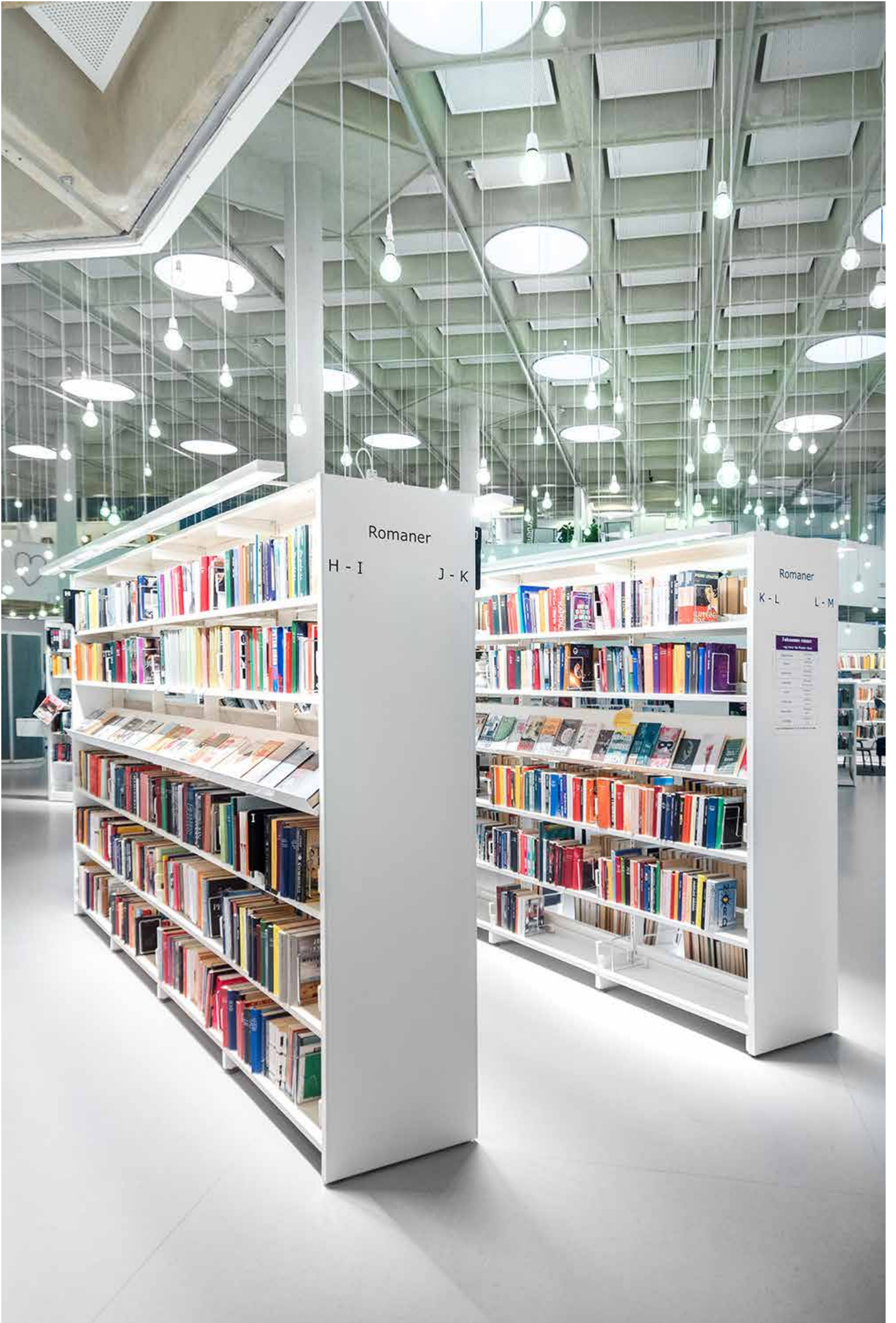

60/30 CLASSIC

The following pages will show basic configurations of the 60/30 Classic Steel Shelving system.



60/30 CLASSIC

SINGLE-SIDED - WITHOUT SHELVES

Configurations with uprights, crossbars, fittings and wall securement. Find shelves from page 66.

Height 92 cm

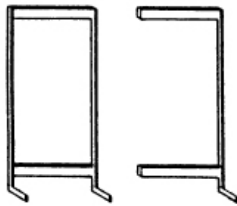

Module cm	Shelf depth cm	Item no. Starter bay	Item no. Add-on bay
75	22.5	BB301007171000	BB301017171000
75	25	BB301007271000	BB301017271000
75	30	BB301007371000	BB301017371000
75	40	BB301007471000	BB301017471000
90	22.5	BB301007191000	BB301017191000
90	25	BB301007291000	BB301017291000
90	30	BB301007391000	BB301017391000
90	40	BB301007491000	BB301017491000
100	22.5	BB301007111000	BB301017111000
100	25	BB301007211000	BB301017211000
100	30	BB301007311000	BB301017311000
100	40	BB301007411000	BB301017411000

Height 122 cm

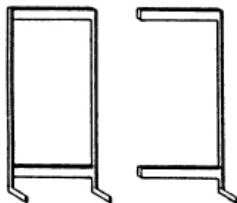

Module cm	Shelf depth cm	Item no. Starter bay	Item no. Add-on bay
75	22.5	BB301002171000	BB301012171000
75	25	BB301002271000	BB301012271000
75	30	BB301002371000	BB301012371000
75	40	BB301002471000	BB301012471000
90	22.5	BB301002191000	BB301012191000
90	25	BB301002291000	BB301012291000
90	30	BB301002391000	BB301012391000
90	40	BB301002491000	BB301012491000
100	22.5	BB301002111000	BB301012111000
100	25	BB301002211000	BB301012211000
100	30	BB301002311000	BB301012311000
100	40	BB301002411000	BB301012411000

Height 152 cm

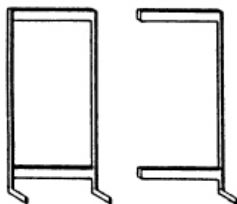

Module cm	Shelf depth cm	Item no. Starter bay	Item no. Add-on bay
75	22.5	BB301005171000	BB301015171000
75	25	BB301005271000	BB301015271000
75	30	BB301005371000	BB301015371000
75	40	BB301005471000	BB301015471000
90	22.5	BB301005191000	BB301015191000
90	25	BB301005291000	BB301015291000
90	30	BB301005391000	BB301015391000
90	40	BB301005491000	BB301015491000
100	22.5	BB301005111000	BB301015111000
100	25	BB301005211000	BB301015211000
100	30	BB301005311000	BB301015311000
100	40	BB301005411000	BB301015411000

60/30 CLASSIC

SINGLE-SIDED - WITHOUT SHELVES

Configurations with uprights, crossbars, fittings and wall securement. Find shelves from page 66.

Height 182 cm

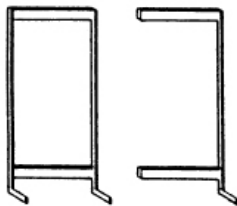

Module cm	Shelf depth cm	Item no. Starter bay	Item no. Add-on bay
75	22.5	BB301008171000	BB301018171000
75	25	BB301008271000	BB301018271000
75	30	BB301008371000	BB301018371000
75	40	BB301008471000	BB301018471000
90	22.5	BB301008191000	BB301018191000
90	25	BB301008291000	BB301018291000
90	30	BB301008391000	BB301018391000
90	40	BB301008491000	BB301018491000
100	22.5	BB301008111000	BB301018111000
100	25	BB301008211000	BB301018211000
100	30	BB301008311000	BB301018311000
100	40	BB301008411000	BB301018411000

Height 212 cm

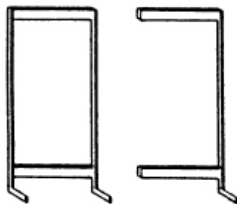

Module cm	Shelf depth cm	Item no. Starter bay	Item no. Add-on bay
75	22.5	BB301001171000	BB301011171000
75	25	BB301001271000	BB301011271000
75	30	BB301001371000	BB301011371000
75	40	BB301001471000	BB301011471000
90	22.5	BB301001191000	BB301011191000
90	25	BB301001291000	BB301011291000
90	30	BB301001391000	BB301011391000
90	40	BB301001491000	BB301011491000
100	22.5	BB301001111000	BB301011111000
100	25	BB301001211000	BB301011211000
100	30	BB301001311000	BB301011311000
100	40	BB301001411000	BB301011411000

60/30 CLASSIC

DOUBLE-SIDED - WITHOUT SHELVES

Configurations with uprights, crossbars and fittings. Find shelves from page 66.

Height 92 cm

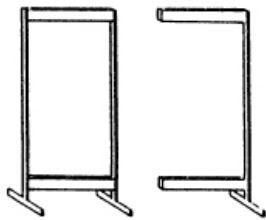

Module cm	Shelf depth cm	Item no. Starter bay	Item no. Add-on bay
75	22.5	BB301007172000	BB301017172000
75	25	BB301007272000	BB301017272000
75	30	BB301007372000	BB301017372000
75	40	BB301007472000	BB301017472000
90	22.5	BB301007192000	BB301017192000
90	25	BB301007292000	BB301017292000
90	30	BB301007392000	BB301017392000
90	40	BB301007492000	BB301017492000
100	22.5	BB301007112000	BB301017112000
100	25	BB301007212000	BB301017212000
100	30	BB301007312000	BB301017312000
100	40	BB301007412000	BB301017412000

Height 122 cm

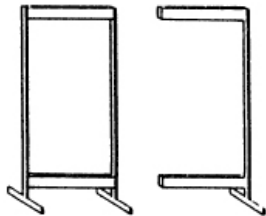

Module cm	Shelf depth cm	Item no. Starter bay	Item no. Add-on bay
75	22.5	BB301002172000	BB301012172000
75	25	BB301002272000	BB301012272000
75	30	BB301002372000	BB301012372000
75	40	BB301002472000	BB301012472000
90	22.5	BB301002192000	BB301012192000
90	25	BB301002292000	BB301012292000
90	30	BB301002392000	BB301012392000
90	40	BB301002492000	BB301012492000
100	22.5	BB301002112000	BB301012112000
100	25	BB301002212000	BB301012212000
100	30	BB301002312000	BB301012312000
100	40	BB301002412000	BB301012412000

Height 152 cm

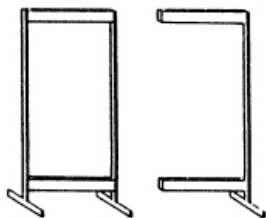

Module cm	Shelf depth cm	Item no. Starter bay	Item no. Add-on bay
75	22.5	BB301005172000	BB301015172000
75	25	BB301005272000	BB301015272000
75	30	BB301005372000	BB301015372000
75	40	BB301005472000	BB301015472000
90	22.5	BB301005192000	BB301015192000
90	25	BB301005292000	BB301015292000
90	30	BB301005392000	BB301015392000
90	40	BB301005492000	BB301015492000
100	22.5	BB301005112000	BB301015112000
100	25	BB301005212000	BB301015212000
100	30	BB301005312000	BB301015312000
100	40	BB301005412000	BB301015412000

60/30 CLASSIC

DOUBLE-SIDED - WITHOUT SHELVES

Configurations with uprights, crossbars and fittings. Find shelves from page 66.

Height 182 cm

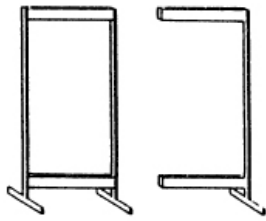

Module cm	Shelf depth cm	Item no. Starter bay	Item no. Add-on bay
75	22.5	BB301008172000	BB301018172000
75	25	BB301008272000	BB301018272000
75	30	BB301008372000	BB301018372000
75	40	BB301008472000	BB301018472000
90	22.5	BB301008192000	BB301018192000
90	25	BB301008292000	BB301018292000
90	30	BB301008392000	BB301018392000
90	40	BB301008492000	BB301018492000
100	22.5	BB301008112000	BB301018112000
100	25	BB301008212000	BB301018212000
100	30	BB301008312000	BB301018312000
100	40	BB301008412000	BB301018412000

Height 212 cm

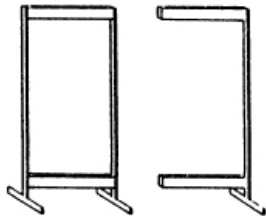

Module cm	Shelf depth cm	Item no. Starter bay	Item no. Add-on bay
75	22.5	BB301001172000	BB301011172000
75	25	BB301001272000	BB301011272000
75	30	BB301001372000	BB301011372000
75	40	BB301001472000	BB301011472000
90	22.5	BB301001192000	BB301011192000
90	25	BB301001292000	BB301011292000
90	30	BB301001392000	BB301011392000
90	40	BB301001492000	BB301011492000
100	22.5	BB301001112000	BB301011112000
100	25	BB301001212000	BB301011212000
100	30	BB301001312000	BB301011312000
100	40	BB301001412000	BB301011412000

60/30 CLASSIC

SINGLE-SIDED - WITH SHELVES - WITHOUT TOP SHELF

Complete shelving system with uprights, crossbars, shelves, brackets, fittings and wall securement. Shelves are steel shelves with backedge. Number of shelves are calculated for optimal shelf spacing for fiction. A starter bay is delivered with one right and one left bracket per shelf. An add-on bay is delivered with a double bracket per shelf, which places the shelves in the same height as that of the starter bay.

Height 92 cm (2 shelves)

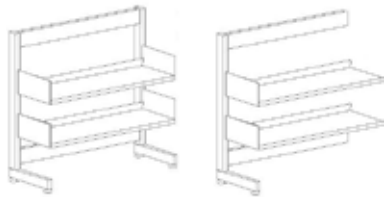

Module cm	Shelf depth cm	Item no. Starter bay	Item no. Add-on bay
75	22.5	BB301007171120	BB301017171120
75	25	BB301007271120	BB301017271120
75	30	BB301007371120	BB301017371120
75	40	BB301007471120	BB301017471120
90	22.5	BB301007191120	BB301017191120
90	25	BB301007291120	BB301017291120
90	30	BB301007391120	BB301017391120
90	40	BB301007491120	BB301017491120
100	22.5	BB301007111120	BB301017111120
100	25	BB301007211120	BB301017211120
100	30	BB301007311120	BB301017311120
100	40	BB301007411120	BB301017411120

Height 122 cm (3 shelves)

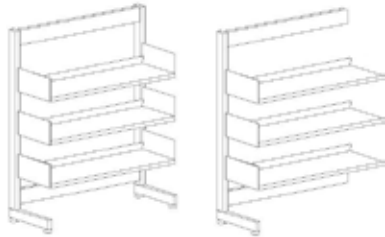

Module cm	Shelf depth cm	Item no. Starter bay	Item no. Add-on bay
75	22.5	BB301002171130	BB301012171130
75	25	BB301002271130	BB301012271130
75	30	BB301002371130	BB301012371130
75	40	BB301002471130	BB301012471130
90	22.5	BB301002191130	BB301012191130
90	25	BB301002291130	BB301012291130
90	30	BB301002391130	BB301012391130
90	40	BB301002491130	BB301012491130
100	22.5	BB301002111130	BB301012111130
100	25	BB301002211130	BB301012211130
100	30	BB301002311130	BB301012311130
100	40	BB301002411130	BB301012411130

Height 152 cm (4 shelves)

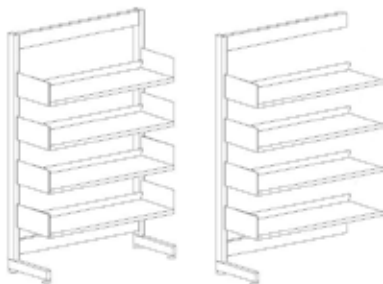

Module cm	Shelf depth cm	Item no. Starter bay	Item no. Add-on bay
75	22.5	BB301005171140	BB301015171140
75	25	BB301005271140	BB301015271140
75	30	BB301005371140	BB301015371140
75	40	BB301005471140	BB301015471140
90	22.5	BB301005191140	BB301015191140
90	25	BB301005291140	BB301015291140
90	30	BB301005391140	BB301015391140
90	40	BB301005491140	BB301015491140
100	22.5	BB301005111140	BB301015111140
100	25	BB301005211140	BB301015211140
100	30	BB301005311140	BB301015311140
100	40	BB301005411140	BB301015411140

60/30 CLASSIC

SINGLE-SIDED - WITH SHELVES - WITHOUT TOP SHELF

Complete shelving system with uprights, crossbars, shelves, brackets, fittings and wall securement. Shelves are steel shelves with backedge. Number of shelves are calculated for optimal shelf spacing for fiction. A starter bay is delivered with one right and one left bracket per shelf. An add-on bay is delivered with a double bracket per shelf, which places the shelves in the same height as that of the starter bay.

Height 182 cm (5 shelves)

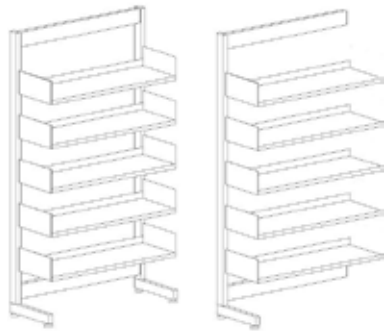

Module cm	Shelf depth cm	Item no. Starter bay	Item no. Add-on bay
75	22.5	BB301008171150	BB301018171150
75	25	BB301008271150	BB301018271150
75	30	BB301008371150	BB301018371150
75	40	BB301008471150	BB301018471150
90	22.5	BB301008191150	BB301018191150
90	25	BB301008291150	BB301018291150
90	30	BB301008391150	BB301018391150
90	40	BB301008491150	BB301018491150
100	22.5	BB301008111150	BB301018111150
100	25	BB301008211150	BB301018211150
100	30	BB301008311150	BB301018311150
100	40	BB301008411150	BB301018411150

Height 212 cm (6 shelves)

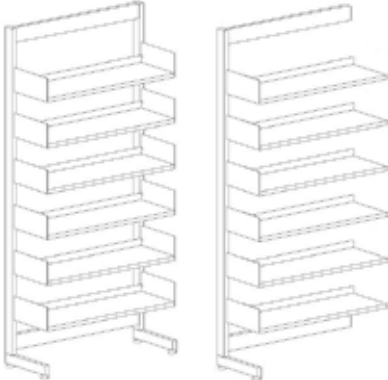

Module cm	Shelf depth cm	Item no. Starter bay	Item no. Add-on bay
75	22.5	BB301001171160	BB301011171160
75	25	BB301001271160	BB301011271160
75	30	BB301001371160	BB301011371160
75	40	BB301001471160	BB301011471160
90	22.5	BB301001191160	BB301011191160
90	25	BB301001291160	BB301011291160
90	30	BB301001391160	BB301011391160
90	40	BB301001491160	BB301011491160
100	22.5	BB301001111160	BB301011111160
100	25	BB301001211160	BB301011211160
100	30	BB301001311160	BB301011311160
100	40	BB301001411160	BB301011411160

60/30 CLASSIC

DOUBLE-SIDED - WITH SHELVES - WITHOUT TOP SHELF

Complete shelving system with uprights, crossbars, shelves, brackets and fittings. Shelves are steel shelves with backedge. Number of shelves are calculated for optimal shelf spacing for fiction. A starter bay is delivered with one right and one left bracket per shelf. An add-on bay is delivered with a double bracket per shelf, which places the shelves in the same height as that of the starter bay.

Height 92 cm (2 shelves on each side)

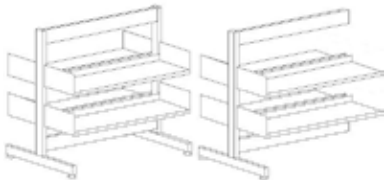
	Module cm	Shelf depth cm	Item no.	Item no.
			Starter bay	Add-on bay
	75	22.5	BB301007172120	BB301017172120
	75	25	BB301007272120	BB301017272120
	75	30	BB301007372120	BB301017372120
	75	40	BB301007472120	BB301017472120
	90	22.5	BB301007192120	BB301017192120
	90	25	BB301007292120	BB301017292120
	90	30	BB301007392120	BB301017392120
	90	40	BB301007492120	BB301017492120
	100	22.5	BB301007112120	BB301017112120
	100	25	BB301007212120	BB301017212120
	100	30	BB301007312120	BB301017312120
	100	40	BB301007412120	BB301017412120

Height 122 cm (3 shelves on each side)

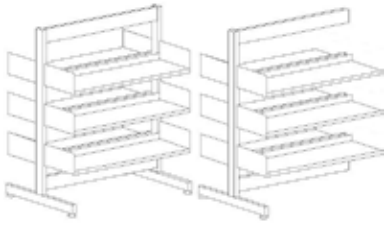
	Module cm	Shelf depth cm	Item no.	Item no.
			Starter bay	Add-on bay
	75	22.5	BB301002172130	BB301012172130
	75	25	BB301002272130	BB301012272130
	75	30	BB301002372130	BB301012372130
	75	40	BB301002472130	BB301012472130
	90	22.5	BB301002192130	BB301012192130
	90	25	BB301002292130	BB301012292130
	90	30	BB301002392130	BB301012392130
	90	40	BB301002492130	BB301012492130
	100	22.5	BB301002112130	BB301012112130
	100	25	BB301002212130	BB301012212130
	100	30	BB301002312130	BB301012312130
	100	40	BB301002412130	BB301012412130

Height 152 cm (4 shelves on each side)

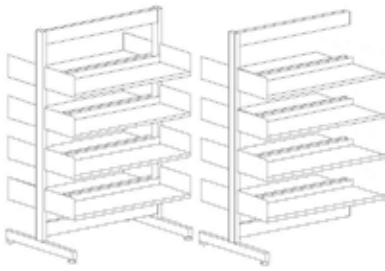
	Module cm	Shelf depth cm	Item no.	Item no.
			Starter bay	Add-on bay
	75	22.5	BB301005172140	BB301015172140
	75	25	BB301005272140	BB301015272140
	75	30	BB301005372140	BB301015372140
	75	40	BB301005472140	BB301015472140
	90	22.5	BB301005192140	BB301015192140
	90	25	BB301005292140	BB301015292140
	90	30	BB301005392140	BB301015392140
	90	40	BB301005492140	BB301015492140
	100	22.5	BB301005112140	BB301015112140
	100	25	BB301005212140	BB301015212140
	100	30	BB301005312140	BB301015312140
	100	40	BB301005412140	BB301015412140

60/30 CLASSIC

DOUBLE-SIDED - WITH SHELVES - WITHOUT TOP SHELF

Complete shelving system with uprights, crossbars, shelves, brackets and fittings. Shelves are steel shelves with backedge. Number of shelves are calculated for optimal shelf spacing for fiction. A starter bay is delivered with one right and one left bracket per shelf. An add-on bay is delivered with a double bracket per shelf, which places the shelves in the same height as that of the starter bay.

Height 182 cm (5 shelves on each side)

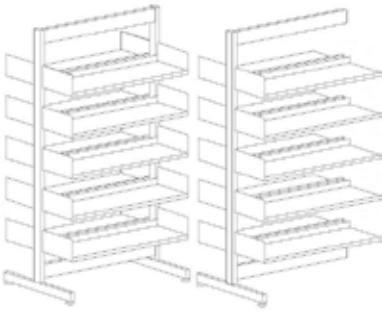
	Module	Shelf depth	Item no.	Item no.
	cm	cm	Starter bay	Add-on bay
	75	22.5	BB301008172150	BB301018172150
	75	25	BB301008272150	BB301018272150
	75	30	BB301008372150	BB301018372150
	75	40	BB301008472150	BB301018472150
	90	22.5	BB301008192150	BB301018192150
	90	25	BB301008292150	BB301018292150
	90	30	BB301008392150	BB301018392150
	90	40	BB301008492150	BB301018492150
	100	22.5	BB301008112150	BB301018112150
	100	25	BB301008212150	BB301018212150
	100	30	BB301008312150	BB301018312150
	100	40	BB301008412150	BB301018412150

Height 212 cm (6 shelves on each side)

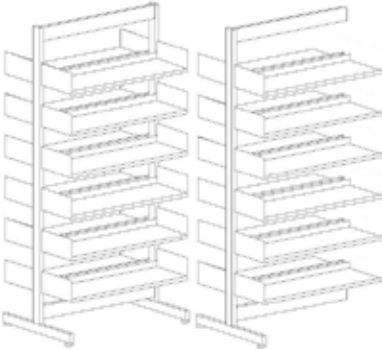
	Module	Shelf depth	Item no.	Item no.
	cm	cm	Starter bay	Add-on bay
	75	22.5	BB301001172160	BB301011172160
	75	25	BB301001272160	BB301011272160
	75	30	BB301001372160	BB301011372160
	75	40	BB301001472160	BB301011472160
	90	22.5	BB301001192160	BB301011192160
	90	25	BB301001292160	BB301011292160
	90	30	BB301001392160	BB301011392160
	90	40	BB301001492160	BB301011492160
	100	22.5	BB301001112160	BB301011112160
	100	25	BB301001212160	BB301011212160
	100	30	BB301001312160	BB301011312160
	100	40	BB301001412160	BB301011412160

60/30 CLASSIC

SINGLE-SIDED - WITH SHELVES AND TOP SHELF

Complete shelving system with uprights, crossbars, shelves, top shelf, brackets, fittings and wall securement. Shelves are steel shelves with backedge, top shelf is steel shelf without backedge. Number of shelves are calculated for optimal shelf spacing for fiction. A starter bay is delivered with one right and one left bracket per shelf. An add-on bay is delivered with a double bracket per shelf, which places the shelves in the same height as that of the starter bay.

Height 92 cm (2 shelves + top shelf)

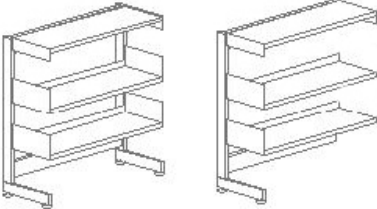
	Module cm	Shelf depth cm	Item no.	Item no.
			Starter bay	Add-on bay
	75	22.5	BB301007171121	BB301017171121
	75	25	BB301007271121	BB301017271121
	75	30	BB301007371121	BB301017371121
	75	40	BB301007471121	BB301017471121
	90	22.5	BB301007191121	BB301017191121
	90	25	BB301007291121	BB301017291121
	90	30	BB301007391121	BB301017391121
	90	40	BB301007491121	BB301017491121
	100	22.5	BB301007111121	BB301017111121
	100	25	BB301007211121	BB301017211121
	100	30	BB301007311121	BB301017311121
	100	40	BB301007411121	BB301017411121

Height 122 cm (3 shelves + top shelf)

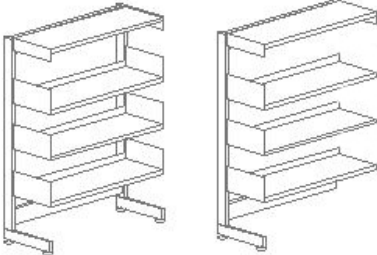
	Module cm	Shelf depth cm	Item no.	Item no.
			Starter bay	Add-on bay
	75	22.5	BB301002171131	BB301012171131
	75	25	BB301002271131	BB301012271131
	75	30	BB301002371131	BB301012371131
	75	40	BB301002471131	BB301012471131
	90	22.5	BB301002191131	BB301012191131
	90	25	BB301002291131	BB301012291131
	90	30	BB301002391131	BB301012391131
	90	40	BB301002491131	BB301012491131
	100	22.5	BB301002111131	BB301012111131
	100	25	BB301002211131	BB301012211131
	100	30	BB301002311131	BB301012311131
	100	40	BB301002411131	BB301012411131

Height 152 cm (4 shelves + top shelf)

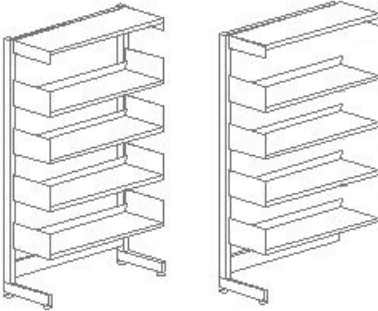
	Module cm	Shelf depth cm	Item no.	Item no.
			Starter bay	Add-on bay
	75	22.5	BB301005171141	BB301015171141
	75	25	BB301005271141	BB301015271141
	75	30	BB301005371141	BB301015371141
	75	40	BB301005471141	BB301015471141
	90	22.5	BB301005191141	BB301015191141
	90	25	BB301005291141	BB301015291141
	90	30	BB301005391141	BB301015391141
	90	40	BB301005491141	BB301015491141
	100	22.5	BB301005111141	BB301015111141
	100	25	BB301005211141	BB301015211141
	100	30	BB301005311141	BB301015311141
	100	40	BB301005411141	BB301015411141

60/30 CLASSIC

SINGLE-SIDED - WITH SHELVES AND TOP SHELF

Complete shelving system with uprights, crossbars, shelves, top shelf, brackets, fittings and wall securement. Shelves are steel shelves with backedge, top shelf is steel shelf without backedge. Number of shelves are calculated for optimal shelf spacing for fiction. A starter bay is delivered with one right and one left bracket per shelf. An add-on bay is delivered with a double bracket per shelf, which places the shelves in the same height as that of the starter bay.

Height 182 cm (5 shelves + top shelf)

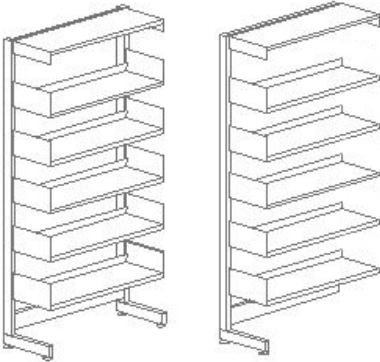
	Module cm	Shelf depth cm	Item no.	Item no.
			Starter bay	Add-on bay
	75	22.5	BB301008171151	BB301018171151
	75	25	BB301008271151	BB301018271151
	75	30	BB301008371151	BB301018371151
	75	40	BB301008371151	BB301018471151
	90	22.5	BB301008191151	BB301018191151
	90	25	BB301008291151	BB301018291151
	90	30	BB301008391151	BB301018391151
	90	40	BB301008491151	BB301018491151
	100	22.5	BB301008111151	BB301018111151
	100	25	BB301008211151	BB301018211151
	100	30	BB301008311151	BB301018311151
	100	40	BB301008411151	BB301018411151

Height 212 cm (6 shelves + top shelf)

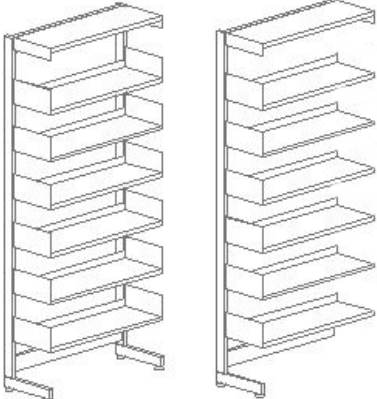
	Module cm	Shelf depth cm	Item no.	Item no.
			Starter bay	Add-on bay
	75	22.5	BB301001171161	BB301011171161
	75	25	BB301001271161	BB301011271161
	75	30	BB301001371161	BB301011371161
	75	40	BB301001471161	BB301011471161
	90	22.5	BB301001191161	BB301011191161
	90	25	BB301001291161	BB301011291161
	90	30	BB301001391161	BB301011391161
	90	40	BB301001491161	BB301011491161
	100	22.5	BB301001111161	BB301011111161
	100	25	BB301001211161	BB301011211161
	100	30	BB301001311161	BB301011311161
	100	40	BB301001411161	BB301011411161

60/30 CLASSIC

DOUBLE-SIDED - WITH SHELVES AND TOP SHELVES

Complete shelving system with uprights, crossbars, shelves, top shelf, brackets and fittings. Shelves are steel shelves with backedge, top shelf is steel shelf without backedge. Number of shelves are calculated for optimal shelf spacing for fiction. A starter bay is delivered with one right and one left bracket per shelf. An add-on bay is delivered with a double bracket per shelf, which places the shelves in the same height as that of the starter bay.

Height 92 cm (2 shelves + top shelf on each side)

	Module cm	Shelf depth cm	Item no.	Item no.
			Starter bay	Add-on bay
	75	22.5	BB301007172121	BB301017172121
	75	25	BB301007272121	BB301017272121
	75	30	BB301007372121	BB301017372121
	75	40	BB301007472121	BB301017472121
	90	22.5	BB301007192121	BB301017192121
	90	25	BB301007292121	BB301017292121
	90	30	BB301007392121	BB301017392121
	90	40	BB301007492121	BB301017492121
	100	22.5	BB301007112121	BB301017112121
	100	25	BB301007212121	BB301017212121
	100	30	BB301007312121	BB301017312121
	100	40	BB301007412121	BB301017412121

Height 122 cm (3 shelves + top shelf on each side)

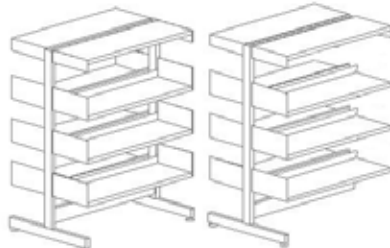
	Module cm	Shelf depth cm	Item no.	Item no.
			Starter bay	Add-on bay
	75	22.5	BB301002172131	BB301012172131
	75	25	BB301002272131	BB301012272131
	75	30	BB301002372131	BB301012372131
	75	40	BB301002472131	BB301012472131
	90	22.5	BB301002192131	BB301012192131
	90	25	BB301002292131	BB301012292131
	90	30	BB301002392131	BB301012392131
	90	40	BB301002492131	BB301012492131
	100	22.5	BB301002112131	BB301012112131
	100	25	BB301002212131	BB301012212131
	100	30	BB301002312131	BB301012312131
	100	40	BB301002412131	BB301012412131

Height 152 cm (4 shelves + top shelf on each side)

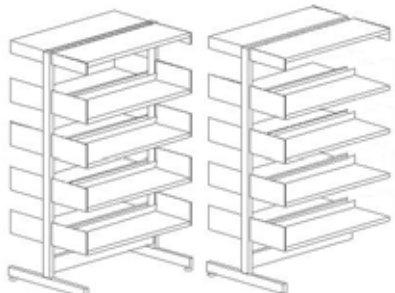
	Module cm	Shelf depth cm	Item no.	Item no.
			Starter bay	Add-on bay
	75	22.5	BB301005172141	BB301015172141
	75	25	BB301005272141	BB301015272141
	75	30	BB301005372141	BB301015372141
	75	40	BB301005472141	BB301015472141
	90	22.5	BB301005192141	BB301015192141
	90	25	BB301005292141	BB301015292141
	90	30	BB301005392141	BB301015392141
	90	40	BB301005492141	BB301015492141
	100	22.5	BB301005112141	BB301015112141
	100	25	BB301005212141	BB301015212141
	100	30	BB301005312141	BB301015312141
	100	40	BB301005412141	BB301015412141

60/30 CLASSIC

DOUBLE-SIDED - WITH SHELVES AND TOP SHELVES

Complete shelving system with uprights, crossbars, shelves, top shelf, brackets and fittings. Shelves are steel shelves with backedge, top shelf is steel shelf without backedge. Number of shelves are calculated for optimal shelf spacing for fiction. A starter bay is delivered with one right and one left bracket per shelf. An add-on bay is delivered with a double bracket per shelf, which places the shelves in the same height as that of the starter bay.

Height 182 cm (5 shelves + top shelf on each side)

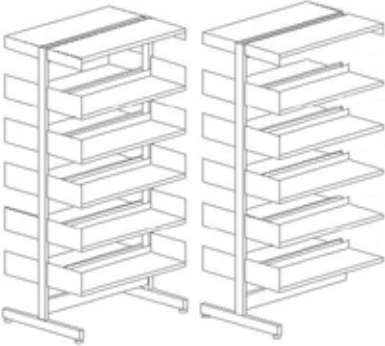
	Module cm	Shelf depth cm	Item no. Starter bay	Item no. Add-on bay
	75	22.5	BB301008172151	BB301018172151
	75	25	BB301008272151	BB301018272151
	75	30	BB301008372151	BB301018372151
	75	40	BB301008472151	BB301018472151
	90	22.5	BB301008192151	BB301018192151
	90	25	BB301008292151	BB301018292151
	90	30	BB301008392151	BB301018392151
	90	40	BB301008492151	BB301018492151
	100	22.5	BB301008112151	BB301018112151
	100	25	BB301008212151	BB301018212151
	100	30	BB301008312151	BB301018312151
	100	40	BB301008412151	BB301018412151

Height 212 cm (6 shelves + top shelf on each side)

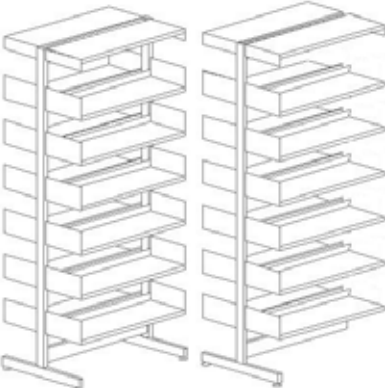
	Module cm	Shelf depth cm	Item no. Starter bay	Item no. Add-on bay
	75	22.5	BB301001172161	BB301011172161
	75	25	BB301001272161	BB301011272161
	75	30	BB301001372161	BB301011372161
	75	40	BB301001472161	BB301011472161
	90	22.5	BB301001192161	BB301011192161
	90	25	BB301001292161	BB301011292161
	90	30	BB301001392161	BB301011392161
	90	40	BB301001492161	BB301011492161
	100	22.5	BB301001112161	BB301011112161
	100	25	BB301001212161	BB301011212161
	100	30	BB301001312161	BB301011312161
	100	40	BB301001412161	BB301011412161

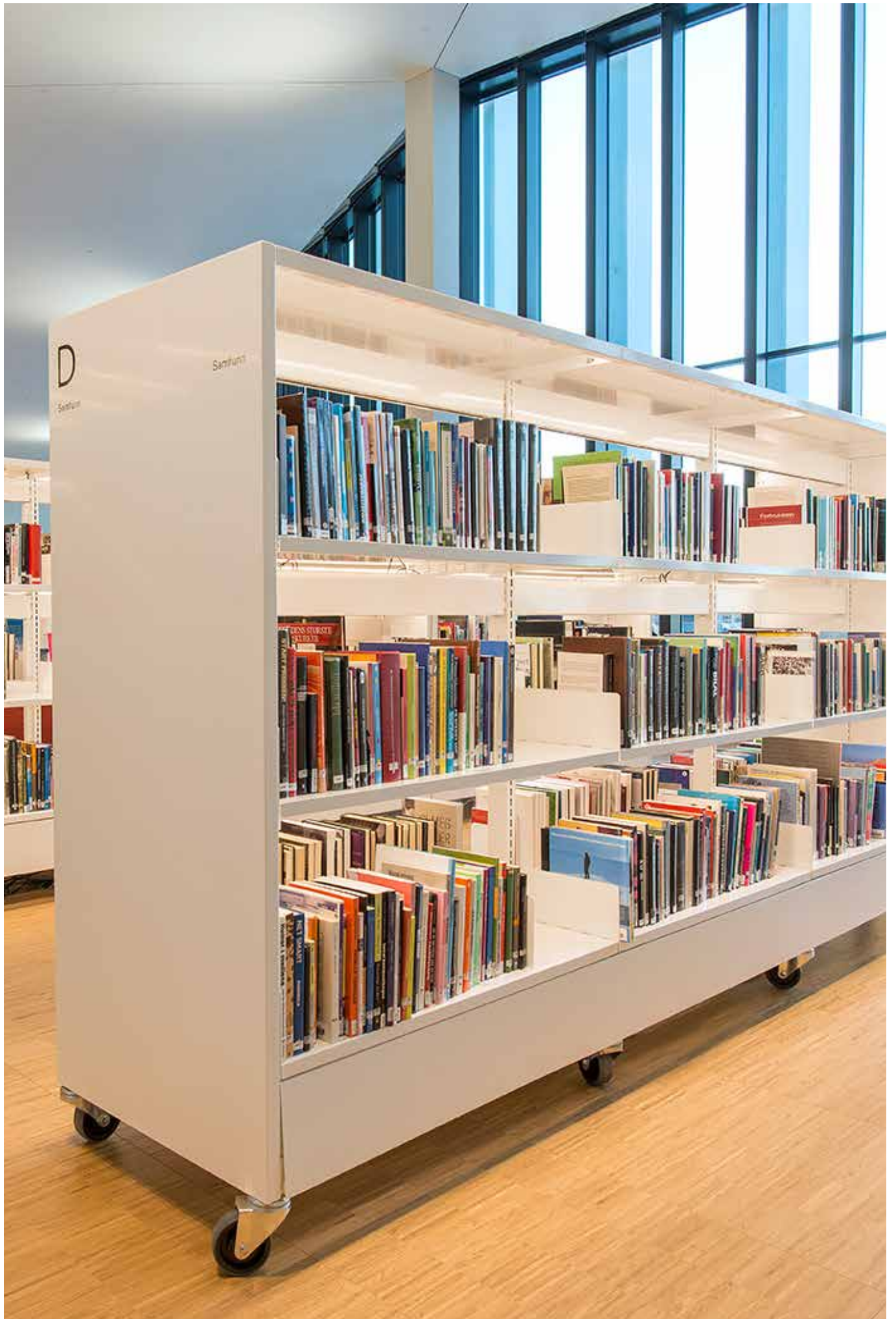

60/30 CLASSIC WITH LED

The following pages will show basic configurations of the 60/30 Classic Steel Shelving system with LED based on 60/30 upright installations.



60/30 CLASSIC WITH LED

SINGLE-SIDED - WITHOUT TOP SHELF AND WITH LED LIGHTING ON INTERMEDIATE SHELVES

Complete shelving system with uprights, cable channels, crossbars, steel shelves with backedge and LED lighting (see page 160 for details on LED lighting), brackets, fittings and wall securement. Cabling from bottom (cabling from above is an option, contact sales). Number of shelves are calculated for optimal shelf spacing for fiction. The LED light is placed underneath each shelf and the cable channel is placed on the left side of the bay. A starter bay is delivered with one right and one left bracket per shelf. An add-on bay is delivered with a double bracket per shelf, which places the shelves in the same height as that of the starter bay.

Height 92 cm (2 shelves and 1 LED light)

Please contact Sales for prices on 60/30 configurations with LED.

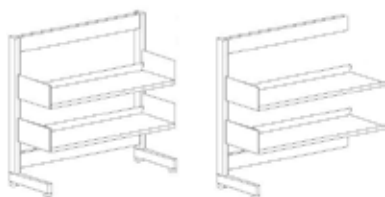

Module cm	Shelf depth cm	Item no. Starter bay	Item no. Add-on bay
75	22.5	BB30203717141120	BB30204717141120
75	25	BB30203727141120	BB30204727141120
75	30	BB30203737141120	BB30204737141120
75	40	BB30203747141120	BB30204747141120
90	22.5	BB30203719141120	BB30204719141120
90	25	BB30203729141120	BB30204729141120
90	30	BB30203739141120	BB30204739141120
90	40	BB30203749141120	BB30204749141120
100	22.5	BB30203711141120	BB30204711141120
100	25	BB30203721141120	BB30204721141120
100	30	BB30203731141120	BB30204731141120
100	40	BB30203741141120	BB30204741141120

Height 122 cm (3 shelves and 2 LED lights)

Please contact Sales for prices on 60/30 configurations with LED.

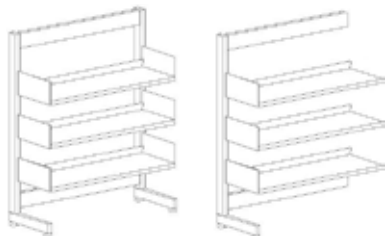

Module cm	Shelf depth cm	Item no. Starter bay	Item no. Add-on bay
75	22.5	BB30203217141130	BB30204217141130
75	25	BB30203227141130	BB30204227141130
75	30	BB30203237141130	BB30204237141130
75	40	BB30203247141130	BB30204247141130
90	22.5	BB30203219141130	BB30204219141130
90	25	BB30203229141130	BB30204229141130
90	30	BB30203239141130	BB30204239141130
90	40	BB30203249141130	BB30204249141130
100	22.5	BB30203211141130	BB30204211141130
100	25	BB30203221141130	BB30204221141130
100	30	BB30203231141130	BB30204231141130
100	40	BB30203241141130	BB30204241141130

Height 152 cm (4 shelves and and 3 LED lights)

Please contact Sales for prices on 60/30 configurations with LED.

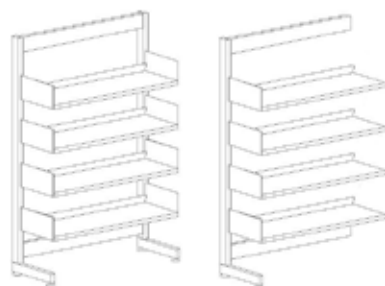

Module cm	Shelf depth cm	Item no. Starter bay	Item no. Add-on bay
75	22.5	BB30203517141140	BB30204517141140
75	25	BB30203527141140	BB30204527141140
75	30	BB30203537141140	BB30204537141140
75	40	BB30203547141140	BB30204547141140
90	22.5	BB30203519141140	BB30204519141140
90	25	BB30203529141140	BB30204529141140
90	30	BB30203539141140	BB30204539141140
90	40	BB30203549141140	BB30204549141140
100	22.5	BB30203511141140	BB30204511141140
100	25	BB30203521141140	BB30204521141140
100	30	BB30203531141140	BB30204531141140
100	40	BB30203541141140	BB30204541141140

60/30 CLASSIC WITH LED

SINGLE-SIDED - WITHOUT TOP SHELF AND WITH LED LIGHTING ON INTERMEDIATE SHELVES

Complete shelving system with uprights, cable channels, crossbars, steel shelves with backedge and LED lighting (see page 160 for details on LED lighting), brackets, fittings and wall securement. Cabling from bottom (cabling from above is an option, contact sales). Number of shelves are calculated for optimal shelf spacing for fiction. The LED light is placed underneath each shelf and the cable channel is placed on the left side of the bay. A starter bay is delivered with one right and one left bracket per shelf. An add-on bay is delivered with a double bracket per shelf, which places the shelves in the same height as that of the starter bay.

Height 182 cm (5 shelves and 4 LED lights)

Please contact Sales for prices on 60/30 configurations with LED.

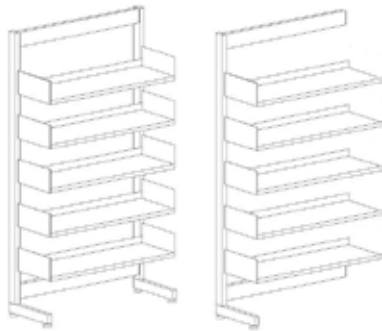

Module cm	Shelf depth cm	Item no. Starter bay	Item no. Add-on bay
75	22.5	BB30203817141150	BB30204817141150
75	25	BB30203827141150	BB30204827141150
75	30	BB30203837141150	BB30204837141150
75	40	BB30203847141150	BB30204847141150
90	22.5	BB30203819141150	BB30204819141150
90	25	BB30203829141150	BB30204829141150
90	30	BB30203839141150	BB30204839141150
90	40	BB30203849141150	BB30204849141150
100	22.5	BB30203811141150	BB30204811141150
100	25	BB30203821141150	BB30204821141150
100	30	BB30203831141150	BB30204831141150
100	40	BB30203841141150	BB30204841141150

Height 212 cm (6 shelves and 5 LED lights)

Please contact Sales for prices on 60/30 configurations with LED.

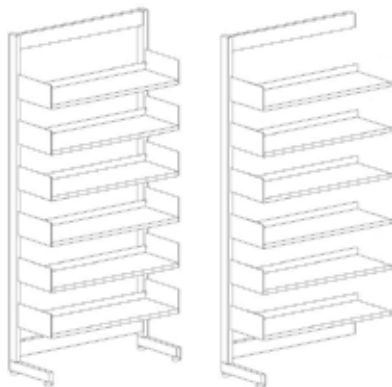

Module cm	Shelf depth cm	Item no. Starter bay	Item no. Add-on bay
75	22.5	BB30203117141160	BB30204117141160
75	25	BB30203127141160	BB30204127141160
75	30	BB30203137141160	BB30204137141160
75	40	BB30203147141160	BB30204147141160
90	22.5	BB30203119141160	BB30204119141160
90	25	BB30203129141160	BB30204129141160
90	30	BB30203139141160	BB30204139141160
90	40	BB30203149141160	BB30204149141160
100	22.5	BB30203111141160	BB30204111141160
100	25	BB30203121141160	BB30204121141160
100	30	BB30203131141160	BB30204131141160
100	40	BB30203141141160	BB30204141141160

60/30 CLASSIC WITH LED

DOUBLE-SIDED - WITHOUT TOP SHELF AND WITH LED LIGHTING ON INTERMEDIATE SHELVES

Complete shelving system with uprights, cable channels, crossbars, steel shelves with backedge and LED lighting (see page 160 for details on LED lighting), brackets and fittings. Cabling from bottom (cabling from above is an option, contact sales). Number of shelves are calculated for optimal shelf spacing for fiction. The LED light is placed underneath each shelf and the cable channel is placed on the left side of the bay. A starter bay is delivered with one right and one left bracket per shelf. An add-on bay is delivered with a double bracket per shelf, which places the shelves in the same height as that of the starter bay.

Height 92 cm (2 shelves and 1 LED light on each side)

Please contact Sales for prices on 60/30 configurations with LED.

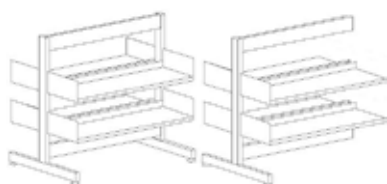

Module cm	Shelf depth cm	Item no. Starter bay	Item no. Add-on bay
75	22.5	BB30203717241120	BB30204717241120
75	25	BB30203727241120	BB30204727241120
75	30	BB30203737241120	BB30204737241120
75	40	BB30203747241120	BB30204747241120
90	22.5	BB30203719241120	BB30204719241120
90	25	BB30203729241120	BB30204729241120
90	30	BB30203739241120	BB30204739241120
90	40	BB30203749241120	BB30204749241120
100	22.5	BB30203711241120	BB30204711241120
100	25	BB30203721241120	BB30204721241120
100	30	BB30203731241120	BB30204731241120
100	40	BB30203741241120	BB30204741241120

Height 122 cm (3 shelves and 2 LED lights on each side)

Please contact Sales for prices on 60/30 configurations with LED.

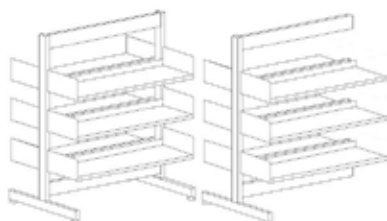

Module cm	Shelf depth cm	Item no. Starter bay	Item no. Add-on bay
75	22.5	BB30203217241130	BB30204217241130
75	25	BB30203227241130	BB30204227241130
75	30	BB30203237241130	BB30204237241130
75	40	BB30203247241130	BB30204247241130
90	22.5	BB30203219241130	BB30204219241130
90	25	BB30203229241130	BB30204229241130
90	30	BB30203239241130	BB30204239241130
90	40	BB30203249241130	BB30204249241130
100	22.5	BB30203211241130	BB30204211241130
100	25	BB30203221241130	BB30204221241130
100	30	BB30203231241130	BB30204231241130
100	40	BB30203241241130	BB30204241241130

Height 152 cm (4 shelves and 3 LED lights on each side)

Please contact Sales for prices on 60/30 configurations with LED.

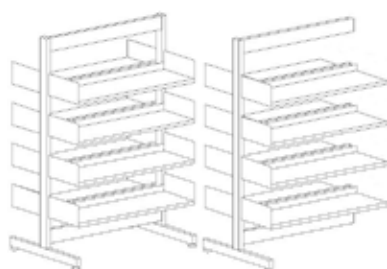

Module cm	Shelf depth cm	Item no. Starter bay	Item no. Add-on bay
75	22.5	BB30203517241140	BB30204517241140
75	25	BB30203527241140	BB30204527241140
75	30	BB30203537241140	BB30204537241140
75	40	BB30203547241140	BB30204547241140
90	22.5	BB30203519241140	BB30204519241140
90	25	BB30203529241140	BB30204529241140
90	30	BB30203539241140	BB30204539241140
90	40	BB30203549241140	BB30204549241140
100	22.5	BB30203511241140	BB30204511241140
100	25	BB30203521241140	BB30204521241140
100	30	BB30203531241140	BB30204531241140
100	40	BB30203541241140	BB30204541241140

60/30 CLASSIC WITH LED

DOUBLE-SIDED - WITHOUT TOP SHELF AND WITH LED LIGHTING ON INTERMEDIATE SHELVES

Complete shelving system with uprights, cable channels, crossbars, steel shelves with backedge and LED lighting (see page 160 for details on LED lighting), brackets and fittings. Cabling from bottom (cabling from above is an option, contact sales). Number of shelves are calculated for optimal shelf spacing for fiction. The LED light is placed underneath each shelf and the cable channel is placed on the left side of the bay. A starter bay is delivered with one right and one left bracket per shelf. An add-on bay is delivered with a double bracket per shelf, which places the shelves in the same height as that of the starter bay.

Height 182 cm (5 shelves and 4 LED lights on each side)

Please contact Sales for prices on 60/30 configurations with LED.

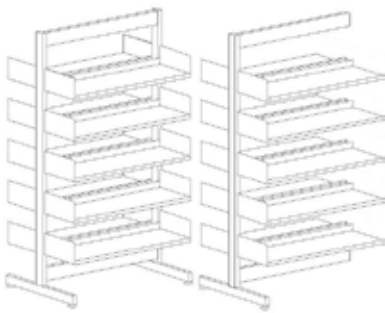

Module cm	Shelf depth cm	Item no. Starter bay	Item no. Add-on bay
75	22.5	BB30203817241150	BB30204817241150
75	25	BB30203827241150	BB30204827241150
75	30	BB30203837241150	BB30204837241150
75	40	BB30203847241150	BB30204847241150
90	22.5	BB30203819241150	BB30204819241150
90	25	BB30203829241150	BB30204829241150
90	30	BB30203839241150	BB30204839241150
90	40	BB30203849241150	BB30204849241150
100	22.5	BB30203811241150	BB30204811241150
100	25	BB30203821241150	BB30204821241150
100	30	BB30203831241150	BB30204831241150
100	40	BB30203841241150	BB30204841241150

Height 212 cm (6 shelves and 5 LED lights on each side)

Please contact Sales for prices on 60/30 configurations with LED.

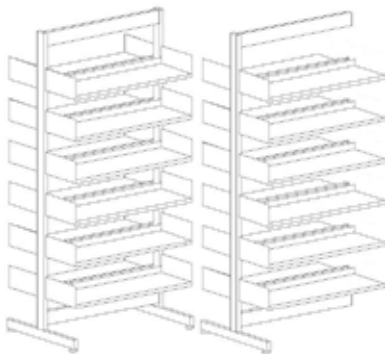

Module cm	Shelf depth cm	Item no. Starter bay	Item no. Add-on bay
75	22.5	BB30203117241160	BB30204117241160
75	25	BB30203127241160	BB30204127241160
75	30	BB30203137241160	BB30204137241160
75	40	BB30203147241160	BB30204147241160
90	22.5	BB30203119241160	BB30204119241160
90	25	BB30203129241160	BB30204129241160
90	30	BB30203139241160	BB30204139241160
90	40	BB30203149241160	BB30204149241160
100	22.5	BB30203111241160	BB30204111241160
100	25	BB30203121241160	BB30204121241160
100	30	BB30203131241160	BB30204131241160
100	40	BB30203241141160	BB30204241141160

60/30 CLASSIC WITH LED

SINGLE-SIDED - WITH TOP SHELF AND LED LIGHTING ON TOP AND INTERMEDIATE SHELVES

Complete shelving system with uprights, cable channels, crossbars, steel shelves with backedge and LED lighting, top shelves with LED lighting (see page 160 for details on LED lighting), brackets, fittings and wall securement. Cabling from bottom (cabling from above is an option, contact sales). Number of shelves are calculated for optimal shelf spacing for fiction. The LED light is placed underneath each shelf and the cable channel is placed on the left side of the bay. A starter bay is delivered with one right and one left bracket per shelf. An add-on bay is delivered with a double bracket per shelf, which places the shelves in the same height as that of the starter bay.

Height 92 cm (1 top shelf, 2 shelves and 2 LED lights)

Please contact Sales for prices on 60/30 configurations with LED.

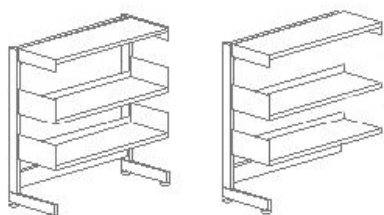

Module cm	Shelf depth cm	Item no. Starter bay	Item no. Add-on bay
75	22.5	BB30203717121121	BB30204717121121
75	25	BB30203727121121	BB30204727121121
75	30	BB30203737121121	BB30204737121121
75	40	BB30203747121121	BB30204747121121
90	22.5	BB30203719121121	BB30204719121121
90	25	BB30203729121121	BB30204729121121
90	30	BB30203739121121	BB30204739121121
90	40	BB30203749121121	BB30204749121121
100	22.5	BB30203711121121	BB30204711121121
100	25	BB30203721121121	BB30204721121121
100	30	BB30203731121121	BB30204731121121
100	40	BB30203741121121	BB30204741121121

Height 122 cm (1 top shelf, 3 shelves and 3 LED lights)

Please contact Sales for prices on 60/30 configurations with LED.

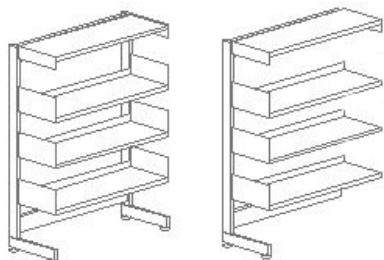

Module cm	Shelf depth cm	Item no. Starter bay	Item no. Add-on bay
75	22.5	BB30203217131131	BB30204217131131
75	25	BB30203227131131	BB30204227131131
75	30	BB30203237131131	BB30204237131131
75	40	BB30203247131131	BB30204247131131
90	22.5	BB30203219131131	BB30204219131131
90	25	BB30203229131131	BB30204229131131
90	30	BB30203239131131	BB30204239131131
90	40	BB30203249131131	BB30204249131131
100	22.5	BB30203211131131	BB30204211131131
100	25	BB30203221131131	BB30204221131131
100	30	BB30203231131131	BB30204231131131
100	40	BB30203241131131	BB30204241131131

Height 152 cm (1 top shelf, 4 shelves and 4 LED lights)

Please contact Sales for prices on 60/30 configurations with LED.

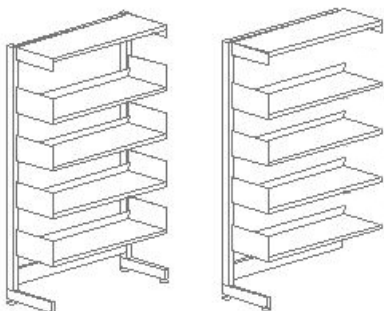

Module cm	Shelf depth cm	Item no. Starter bay	Item no. Add-on bay
75	22.5	BB30203517131141	BB30204517131141
75	25	BB30203527131141	BB30204527131141
75	30	BB30203537131141	BB30204537131141
75	40	BB30203547131141	BB30204547131141
90	22.5	BB30203519131141	BB30204519131141
90	25	BB30203529131141	BB30204529131141
90	30	BB30203539131141	BB30204539131141
90	40	BB30203549131141	BB30204549131141
100	22.5	BB30203511131141	BB30204511131141
100	25	BB30203521131141	BB30204521131141
100	30	BB30203531131141	BB30204531131141
100	40	BB30203541131141	BB30204541131141

60/30 CLASSIC WITH LED

SINGLE-SIDED - WITH TOP SHELF AND LED LIGHTING ON TOP AND INTERMEDIATE SHELVES

Complete shelving system with uprights, cable channels, crossbars, steel shelves with backedge and LED lighting, top shelves with LED lighting (see page 160 for details on LED lighting), brackets, fittings and wall securement. Cabling from bottom (cabling from above is an option, contact sales). Number of shelves are calculated for optimal shelf spacing for fiction. The LED light is placed underneath each shelf and the cable channel is placed on the left side of the bay. A starter bay is delivered with one right and one left bracket per shelf. An add-on bay is delivered with a double bracket per shelf, which places the shelves in the same height as that of the starter bay.

Height 182 cm (1 top shelf, 5 shelves and 5 LED lights)

Please contact Sales for prices on 60/30 configurations with LED.

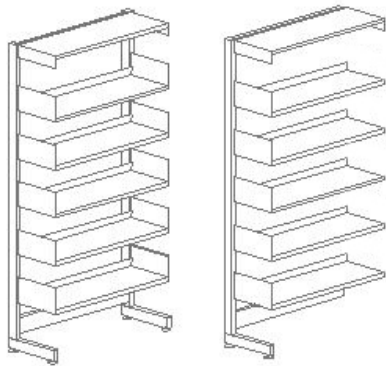

Module cm	Shelf depth cm	Item no. Starter bay	Item no. Add-on bay
75	22.5	BB30203817131151	BB30204817131151
75	25	BB30203827131151	BB30204827131151
75	30	BB30203837131151	BB30204837131151
75	40	BB30203847131151	BB30204847131151
90	22.5	BB30203819131151	BB30204819131151
90	25	BB30203829131151	BB30204829131151
90	30	BB30203839131151	BB30204839131151
90	40	BB30203849131151	BB30204849131151
100	22.5	BB30203811131151	BB30204811131151
100	25	BB30203821131151	BB30204821131151
100	30	BB30203831131151	BB30204831131151
100	40	BB30203841131151	BB30204841131151

Height 212 cm (1 top shelf, 6 shelves and 6 LED lights)

Please contact Sales for prices on 60/30 configurations with LED.

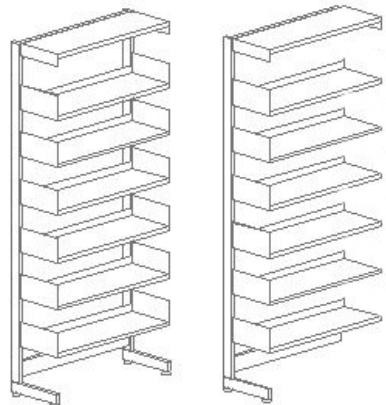

Module cm	Shelf depth cm	Item no. Starter bay	Item no. Add-on bay
75	22.5	BB30203117131161	BB30204117131161
75	25	BB30203127131161	BB30204127131161
75	30	BB30203137131161	BB30204137131161
75	40	BB30203147131161	BB30204147131161
90	22.5	BB30203119131161	BB30204119131161
90	25	BB30203129131161	BB30204129131161
90	30	BB30203139131161	BB30204139131161
90	40	BB30203149131161	BB30204149131161
100	22.5	BB30203111131161	BB30204111131161
100	25	BB30203121131161	BB30204121131161
100	30	BB30203131131161	BB30204131131161
100	40	BB30203141131161	BB30204141131161

60/30 CLASSIC WITH LED

DOUBLE-SIDED - WITH TOP SHELF AND LED LIGHTING ON TOP AND INTERMEDIATE SHELVES

Complete shelving system with uprights, cable channels, crossbars, steel shelves with backedge and LED lighting, top shelves with LED lighting (see page 160 for details on LED lighting), brackets and fittings. Cabling from bottom (cabling from above is an option, contact sales). Number of shelves are calculated for optimal shelf spacing for fiction. The LED light is placed underneath each shelf and the cable channel is placed on the left side of the bay. A starter bay is delivered with one right and one left bracket per shelf. An add-on bay is delivered with a double bracket per shelf, which places the shelves in the same height as that of the starter bay.

Height 92 cm (1 top shelf, 2 shelves and 2 LED lights on each side)

Please contact Sales for prices on 60/30 configurations with LED.

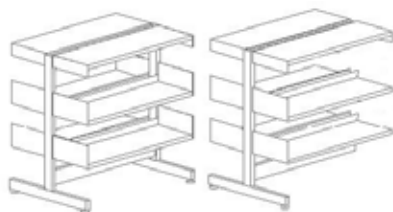

Module cm	Shelf depth cm	Item no. Starter bay	Item no. Add-on bay
75	22.5	BB30203717231121	BB30204717231121
75	25	BB30203727231121	BB30204727231121
75	30	BB30203737231121	BB30204737231121
75	40	BB30203747231121	BB30204747231121
90	22.5	BB30203719231121	BB30204719231121
90	25	BB30203729231121	BB30204729231121
90	30	BB30203739231121	BB30204739231121
90	40	BB30203749231121	BB30204749231121
100	22.5	BB30203711231121	BB30204711231121
100	25	BB30203721231121	BB30204721231121
100	30	BB30203731231121	BB30204731231121
100	40	BB30203741231121	BB30204741231121

Height 122 cm (1 top shelf, 3 shelves and 3 LED lights on each side)

Please contact Sales for prices on 60/30 configurations with LED.

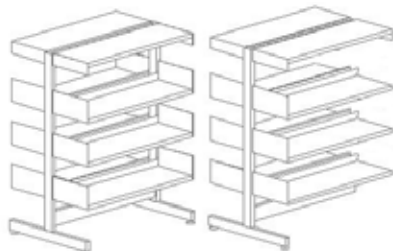

Module cm	Shelf depth cm	Item no. Starter bay	Item no. Add-on bay
75	22.5	BB30203217231131	BB30204217231131
75	25	BB30203227231131	BB30204227231131
75	30	BB30203237231131	BB30204237231131
75	40	BB30203247231131	BB30204247231131
90	22.5	BB30203219231131	BB30204219231131
90	25	BB30203229231131	BB30204229231131
90	30	BB30203239231131	BB30204239231131
90	40	BB30203249231131	BB30204249231131
100	22.5	BB30203211231131	BB30204211231131
100	25	BB30203221231131	BB30204221231131
100	30	BB30203231231131	BB30204231231131
100	40	BB30203241231131	BB30204241231131

Height 152 cm (1 top shelf, 4 shelves and 4 LED lights on each side)

Please contact Sales for prices on 60/30 configurations with LED.

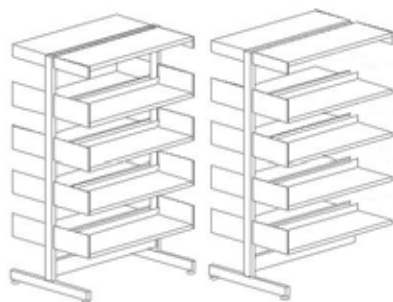

Module cm	Shelf depth cm	Item no. Starter bay	Item no. Add-on bay
75	22.5	BB30203517231141	BB30204517231141
75	25	BB30203527231141	BB30204527231141
75	30	BB30203537231141	BB30204537231141
75	40	BB30203547231141	BB30204547231141
90	22.5	BB30203519231141	BB30204519231141
90	25	BB30203529231141	BB30204529231141
90	30	BB30203539231141	BB30204539231141
90	40	BB30203549231141	BB30204549231141
100	22.5	BB30203511231141	BB30204511231141
100	25	BB30203521231141	BB30204521231141
100	30	BB30203531231141	BB30204531231141
100	40	BB30203541231141	BB30204541231141

60/30 CLASSIC WITH LED

DOUBLE-SIDED - WITH TOP SHELF AND LED LIGHTING ON TOP AND INTERMEDIATE SHELVES

Complete shelving system with uprights, cable channels, crossbars, steel shelves with backedge and LED lighting, top shelves with LED lighting (see page 160 for details on LED lighting), brackets and fittings. Cabling from bottom (cabling from above is an option, contact sales). Number of shelves are calculated for optimal shelf spacing for fiction. The LED light is placed underneath each shelf and the cable channel is placed on the left side of the bay. A starter bay is delivered with one right and one left bracket per shelf. An add-on bay is delivered with a double bracket per shelf, which places the shelves in the same height as that of the starter bay.

Height 182 cm (1 top shelf, 5 shelves and 5 LED lights on each side)

Please contact Sales for prices on 60/30 configurations with LED.

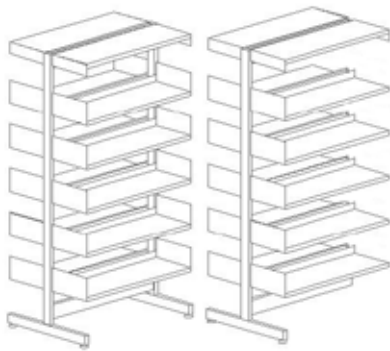

Module cm	Shelf depth cm	Item no. Starter bay	Item no. Add-on bay
75	22.5	BB30203817231151	BB30204817231151
75	25	BB30203827231151	BB30204827231151
75	30	BB30203837231151	BB30204837231151
75	40	BB30203847231151	BB30204847231151
90	22.5	BB30203819231151	BB30204819231151
90	25	BB30203829231151	BB30204829231151
90	30	BB30203839231151	BB30204839231151
90	40	BB30203849231151	BB30204849231151
100	22.5	BB30203811231151	BB30204811231151
100	25	BB30203821231151	BB30204821231151
100	30	BB30203831231151	BB30204831231151
100	40	BB30203841231151	BB30204841231151

Height 212 cm (1 top shelf, 6 shelves and 6 LED lights on each side)

Please contact Sales for prices on 60/30 configurations with LED.

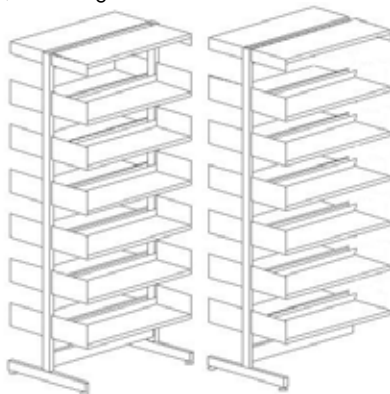

Module cm	Shelf depth cm	Item no. Starter bay	Item no. Add-on bay
75	22.5	BB30203117231161	BB30204117231161
75	25	BB30203127231161	BB30204127231161
75	30	BB30203137231161	BB30204137231161
75	40	BB30203147231161	BB30204147231161
90	22.5	BB30203119231161	BB30204119231161
90	25	BB30203129231161	BB30204129231161
90	30	BB30203139231161	BB30204139231161
90	40	BB30203149231161	BB30204149231161
100	22.5	BB30203111231161	BB30204111231161
100	25	BB30203121231161	BB30204121231161
100	30	BB30203131231161	BB30204131231161
100	40	BB30203141231161	BB30204141231161



80/30 CLASSIC STEEL SHELVING

The following pages will show basic configurations of the 60/30 Classic Steel Shelving system based on 80/30 upright installations. The wider construction of this upright allows for greater total weight and also a taller construction.



80/30 CLASSIC STEEL SHELVING

SINGLE-SIDED - WITH TOP SHELF

Complete shelving system with uprights, crossbars, shelves, top shelf, brackets, fittings and wall securement. Shelves are steel shelves with backedge, top shelf is steel shelf without backedge. Number of shelves are calculated for optimal shelf spacing for fiction. A starter bay is delivered with one right and one left bracket per shelf. An add-on bay is delivered with a double bracket per shelf, which places the shelves in the same height as that of the starter bay. Please note that standard end panels do not fit on 80/30 steel shelving and must be ordered specially, please contact customer service.

Height 199 cm (5 shelves + top shelf)

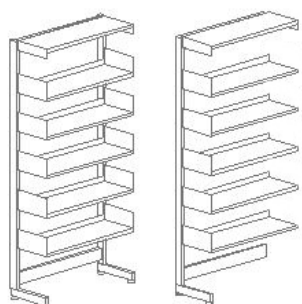
	Module cm	Shelf depth cm	Item no.	Item no.
			Starter bay	Add-on bay
	75	22.5	BB304003171151	BB304013171151
	75	25	BB304003271151	BB304013271151
	75	30	BB304003371151	BB304013371151
	75	40	BB304003471151	BB304013471151
	90	22.5	BB304003191151	BB304013191151
	90	25	BB304003291151	BB304013291151
	90	30	BB304003391151	BB304013391151
	90	40	BB304003491151	BB304013491151
	100	22.5	BB304003111151	BB304013111151
	100	25	BB304003211151	BB304013211151
	100	30	BB304003311151	BB304013311151
	100	40	BB304003411151	BB304013411151

Height 229 cm (6 shelves + top shelf)

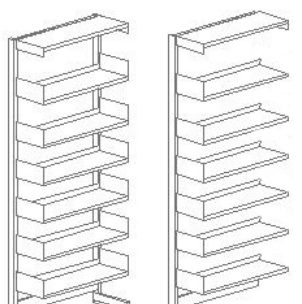
	Module cm	Shelf depth cm	Item no.	Item no.
			Starter bay	Add-on bay
	75	22.5	BB304002171161	BB304012171161
	75	25	BB304002271161	BB304012271161
	75	30	BB304002371161	BB304012371161
	75	40	BB304002471161	BB304012471161
	90	22.5	BB304002191161	BB304012191161
	90	25	BB304002291161	BB304012291161
	90	30	BB304002391161	BB304012391161
	90	40	BB304002491161	BB304012491161
	100	22.5	BB304002111161	BB304012111161
	100	25	BB304002211161	BB304012211161
	100	30	BB304002311161	BB304012311161
	100	40	BB304002411161	BB304012411161

Height 259 cm (7 shelves + top shelf)

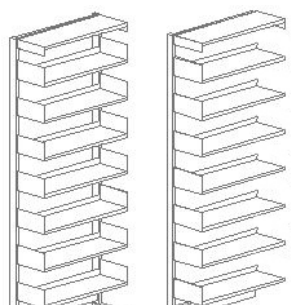
	Module cm	Shelf depth cm	Item no.	Item no.
			Starter bay	Add-on bay
	75	22.5	BB304001171171	BB304011171171
	75	25	BB304001271171	BB304011271171
	75	30	BB304001371171	BB304011371171
	75	40	BB304001471171	BB304011471171
	90	22.5	BB304001191171	BB304011191171
	90	25	BB304001291171	BB304011291171
	90	30	BB304001391171	BB304011391171
	90	40	BB304001491171	BB304011491171
	100	22.5	BB304001111171	BB304011111171
	100	25	BB304001211171	BB304011211171
	100	30	BB304001311171	BB304011311171
	100	40	BB304001411171	BB304011411171

80/30 CLASSIC STEEL SHELVING

DOUBLE-SIDED - WITH TOP SHELF

Complete shelving system with uprights, crossbars, shelves, top shelf, brackets and fittings. Shelves are steel shelves with backedge, top shelf is steel shelf without backedge. Number of shelves are calculated for optimal shelf spacing for fiction. A starter bay is delivered with one right and one left bracket per shelf. An add-on bay is delivered with a double bracket per shelf, which places the shelves in the same height as that of the starter bay. Please note that standard end panels do not fit on 80/30 steel shelving and must be ordered specially, please contact customer service.

Height 199 cm (5 shelves + top shelf on each side)

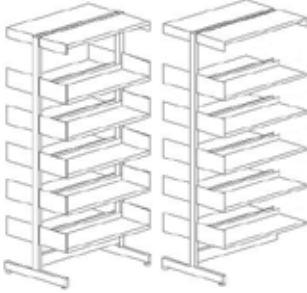
	Module cm	Shelf depth cm	Item no.	Item no.
			Starter bay	Add-on bay
	75	22.5	BB304003172151	BB304013172151
	75	25	BB304003272151	BB304013272151
	75	30	BB304003372151	BB304013372151
	75	40	BB304003472151	BB304013472151
	90	22.5	BB304003192151	BB304013192151
	90	25	BB304003292151	BB304013292151
	90	30	BB304003392151	BB304013392151
	90	40	BB304003492151	BB304013492151
	100	22.5	BB304003112151	BB304013112151
	100	25	BB304003212151	BB304013212151
	100	30	BB304003312151	BB304013312151
	100	40	BB304003412151	BB304013412151

Height 229 cm (6 shelves + top shelf on each side)

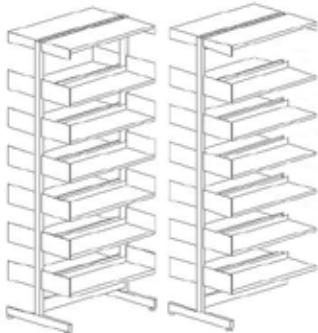
	Module cm	Shelf depth cm	Item no.	Item no.
			Starter bay	Add-on bay
	75	22.5	BB304002172161	BB304012172161
	75	25	BB304002272161	BB304012272161
	75	30	BB304002372161	BB304012372161
	75	40	BB304002472161	BB304012472161
	90	22.5	BB304002192161	BB304012192161
	90	25	BB304002292161	BB304012292161
	90	30	BB304002392161	BB304012392161
	90	40	BB304002492161	BB304012492161
	100	22.5	BB304002112161	BB304012112161
	100	25	BB304002212161	BB304012212161
	100	30	BB304002312161	BB304012312161
	100	40	BB304002412161	BB304012412161

Height 259 cm (7 shelves + top shelf on each side)

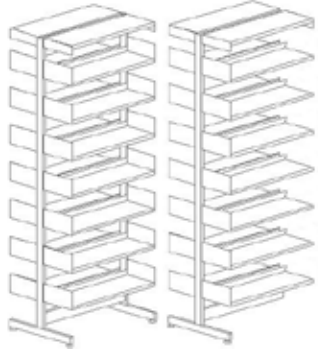
	Module cm	Shelf depth cm	Item no.	Item no.
			Starter bay	Add-on bay
	75	22.5	BB304001172171	BB304011172171
	75	25	BB304001272171	BB304011272171
	75	30	BB304001372171	BB304011372171
	75	40	BB304001472171	BB304011472171
	90	22.5	BB304001192171	BB304011192171
	90	25	BB304001292171	BB304011292171
	90	30	BB304001392171	BB304011392171
	90	40	BB304001492171	BB304011492171
	100	22.5	BB304001112171	BB304011112171
	100	25	BB304001212171	BB304011212171
	100	30	BB304001312171	BB304011312171
	100	40	BB304001412171	BB304011412171



60/30 CLASSIC STEEL SHELVING - WALL

The following pages will show basic configurations of the 60/30 Classic Steel Shelving system based on 60/30 Classic wall strip installations.



CLASSIC STEEL SHELVING - WALL

WITH TOP SHELF

Complete shelving system with wall strips, shelves, top shelf, brackets and fittings. Shelves are steel shelves with backedge, top shelf is steel shelf without backedge. Number of shelves are calculated for optimal shelf spacing for fiction. A starter bay is delivered with one right and one left bracket per shelf. An add-on bay is delivered with a double bracket per shelf, which places the shelves in the same height as that of the starter bay. Please note that standard end panels do not fit on 60/30 wall steel shelving and must be ordered specially, please contact customer service.

Height 112.5 cm (3 shelves + top shelf)

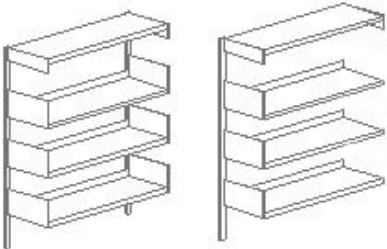
	Module cm	Shelf depth cm	Item no. Starter bay	Item no. Add-on bay
	75	22.5	BB302001117131	BB302011117131
	75	25	BB302001127131	BB302011127131
	75	30	BB302001137131	BB302011137131
	75	40	BB302001147131	BB302011147131
	90	22.5	BB302001119131	BB302011119131
	90	25	BB302001129131	BB302011129131
	90	30	BB302001139131	BB302011139131
	90	40	BB302001149131	BB302011149131
	100	22.5	BB302001111131	BB302011111131
	100	25	BB302001121131	BB302011121131
	100	30	BB302001131131	BB302011131131
	100	40	BB302001141131	BB302011141131

Height 142.5 cm (4 shelves + top shelf)

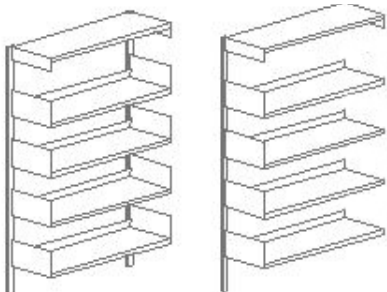
	Module cm	Shelf depth cm	Item no. Starter bay	Item no. Add-on bay
	75	22.5	BB302001417141	BB302011417141
	75	25	BB302001427141	BB302011427141
	75	30	BB302001437141	BB302011437141
	75	40	BB302001447141	BB302011447141
	90	22.5	BB302001419141	BB302011419141
	90	25	BB302001429141	BB302011429141
	90	30	BB302001439141	BB302011439141
	90	40	BB302001449141	BB302011449141
	100	22.5	BB302001411141	BB302011411141
	100	25	BB302001421141	BB302011421141
	100	30	BB302001431141	BB302011431141
	100	40	BB302001441141	BB302011441141

CLASSIC STEEL SHELVING - WALL

WITH TOP SHELF

Complete shelving system with wall strips, shelves, top shelf, brackets and fittings. Shelves are steel shelves with backedge, top shelf is steel shelf without backedge. Number of shelves are calculated for optimal shelf spacing for fiction. A starter bay is delivered with one right and one left bracket per shelf. An add-on bay is delivered with a double bracket per shelf, which places the shelves in the same height as that of the starter bay. Please note that standard end panels do not fit on 60/30 wall steel shelving and must be ordered specially, please contact customer service.

Height 172.5 cm (5 shelves + top shelf)

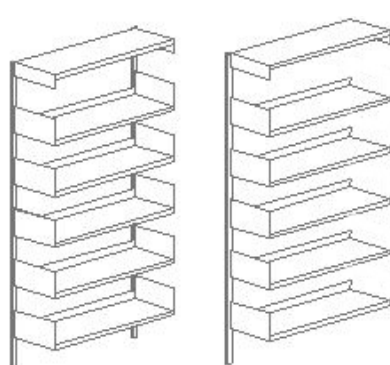
		Module cm	Shelf depth cm	Item no. Starter bay	Item no. Add-on bay
	75	22.5	BB302001717151	BB302011717151	
	75	25	BB302001727151	BB302011727151	
	75	30	BB302001737151	BB302011737151	
	75	40	BB302001747151	BB302011747151	
	90	22.5	BB302001719151	BB302011719151	
	90	25	BB302001729151	BB302011729151	
	90	30	BB302001739151	BB302011739151	
	90	40	BB302001749151	BB302011749151	
100	22.5	BB302001711151	BB302011711151		
100	25	BB302001721151	BB302011721151		
100	30	BB302001731151	BB302011731151		
100	40	BB302001741151	BB302011741151		

Height 202.5 cm (6 shelves + top shelf)

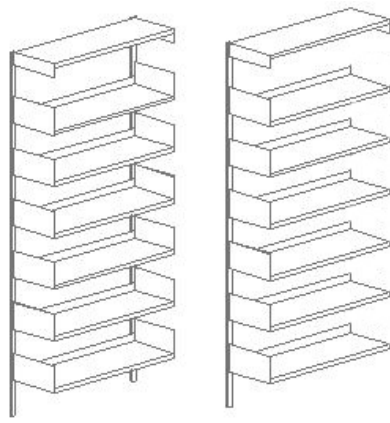
		Module cm	Shelf depth cm	Item no. Starter bay	Item no. Add-on bay
	75	22.5	BB302002017161	BB302012017161	
	75	25	BB302002027161	BB302012027161	
	75	30	BB302002037161	BB302012037161	
	75	40	BB302002047161	BB302012047161	
	90	22.5	BB302002019161	BB302012019161	
	90	25	BB302002029161	BB302012029161	
	90	30	BB302002039161	BB302012039161	
	90	40	BB302002049161	BB302012049161	
	100	22.5	BB302002011161	BB302012011161	
	100	25	BB302002021161	BB302012021161	
	100	30	BB302002031161	BB302012031161	
	100	40	BB302002041161	BB302012041161	

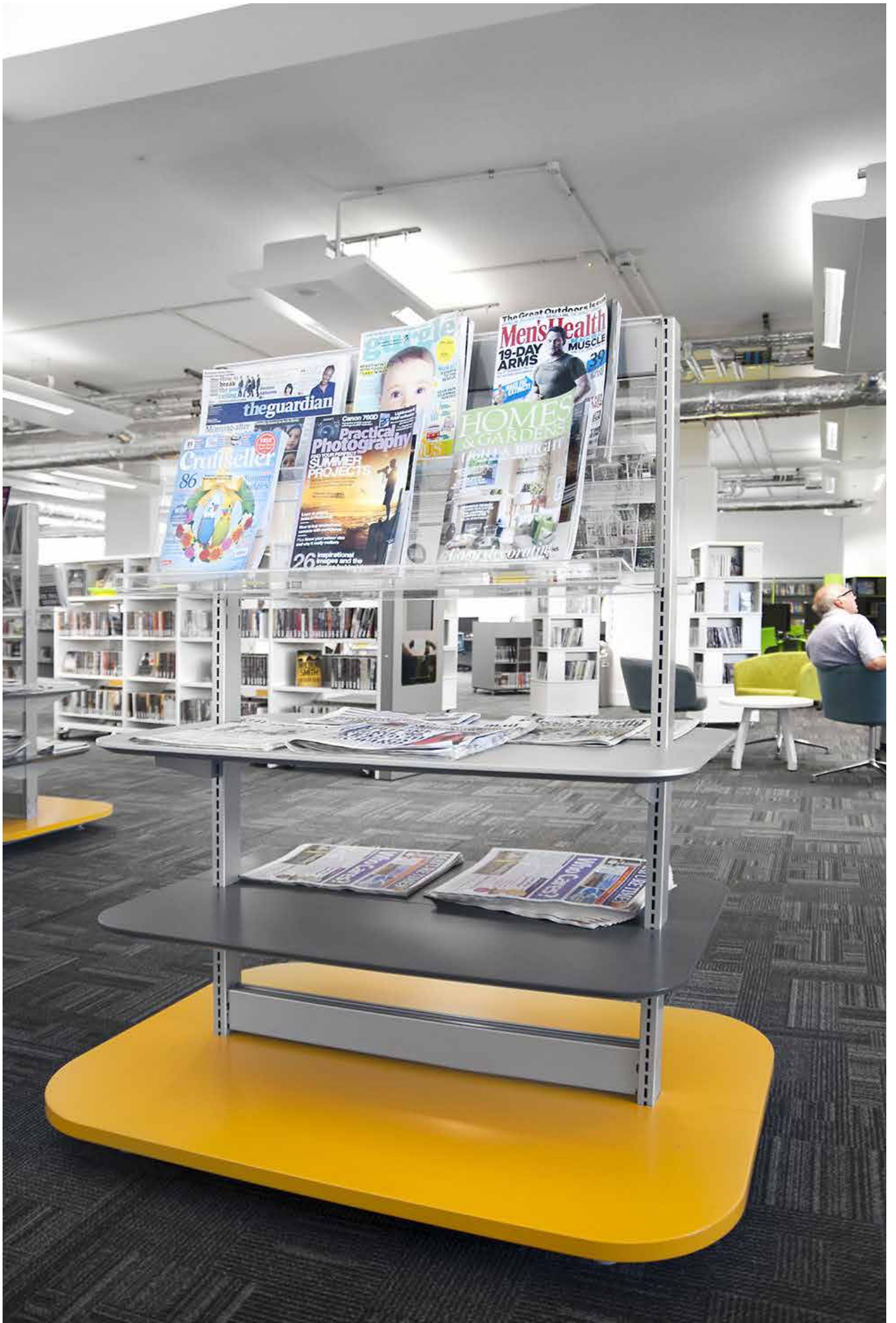

On the following pages you will find a selection of 60/30 Expo configurations including prices and lists of components included in the specific configuration. Please note that other configurations are available.

60/30 Expo is available as double-sided over a maximum of 3 bays. It consists of components, which are used for the 60/30 Classic shelving configurations along with a series of specific 60/30 Expo components. 60/30 Expo is made of steel uprights, painted wooden shelves and acrylic display shelves. The steel uprights and painted wooden shelves are available in all our standard colours. Note that wooden shelves cannot be placed next to an acrylic shelf and wooden shelves cannot be placed in front of back panels.

Acrylic display shelf

Shelf depth cm	Item no.
30	B30850039

Bracket for shelf

Shelf depth cm	Item no. Starter bay
30	B3085043

Double-sided bottom shelf with round corners



No. of bays	Item no. Painted
1	B308505392155
2	B308505392255
3	B308505392355

Double-sided shelf with round corners



No. of bays	Item no. Painted
1	B308508392155
2	B308508392255
3	B308508392355

Double-sided shelf for back panel with round corners



No. of bays	Item no. Painted
1	B308511392145
2	B308511392245

Castors

H9.9 cm.

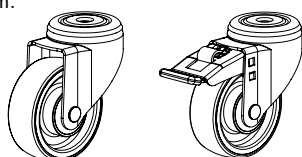

Brakes	Item no.
Without	B3060000
With	B3060001

60/30 EXPO

DOUBLE-SIDED - H122 CM - 1 BAY

Height 122 cm - 1 bay

Module 90 cm / depth 30 cm

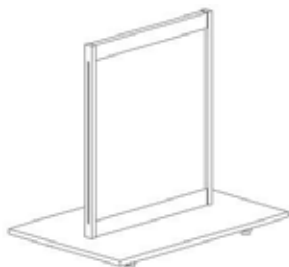

The configurations consist of the following components:

Component	Round corners Item no.	Quantity
Upright	B301000232	2
Crossbar	B3010129	2
Back panel	B301900295	1
Bottom shelf	B30850539215	1

Round corners Configuration

Expo 34

Height 122 cm - 1 bay

Module 90 cm / depth 30 cm

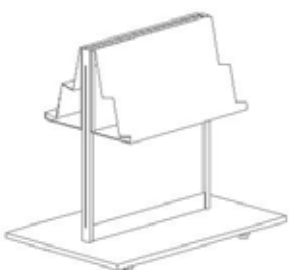

The configurations consist of the following components:

Component	Round corners Item no.	Quantity
Upright	B301000232	2
Crossbar	B3010129	2
Back panel	B301900295	1
Bottom shelf	B30850539215	1
Acrylic display shelf	B30850039	2

Round corners Configuration

Expo 35

Height 122 cm - 1 bay

Module 90 cm / depth 30 cm

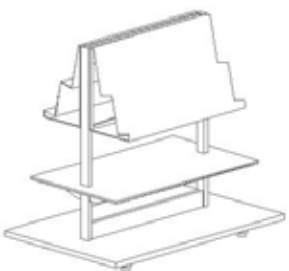

The configurations consist of the following components:

Component	Round corners Item no.	Quantity
Upright	B301000232	2
Crossbar	B3010129	2
Bottom shelf	B30850539215	1
Acrylic display shelf	B30850039	2
Shelf	B30850839215	1
Bracket for shelf	B3085043	4

Round corners Configuration

Expo 36

Height 122 cm - 1 bay

Module 90 cm / depth 30 cm

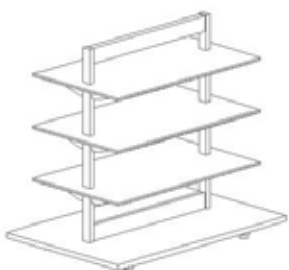

The configurations consist of the following components:

Component	Round corners Item no.	Quantity
Upright	B301000232	2
Crossbar	B3010129	2
Bottom shelf	B30850539215	1
Shelf	B30850839215	3
Bracket for shelf	B3085043	12

Round corners Configuration

Expo 37

60/30 EXPO

DOUBLE-SIDED - H122 CM - 2 BAYS

Height 122 cm - 2 bays

Module 90 cm / depth 30 cm

Round corners
Configuration

Expo 38

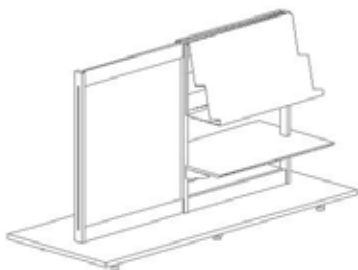

The configurations consist of the following components:

Component	Round corners Item no.	Quantity
Upright	B301000232	3
Crossbar	B3010129	4
Back panel	B301900295	1
Bottom shelf	B30850539225	1
Acrylic display shelf	B30850039	2
Shelf	B30851139214	1
Bracket for shelf	B3085043	4

Height 122 cm - 2 bays

Module 90 cm / depth 30 cm

Round corners
Configuration

Expo 39

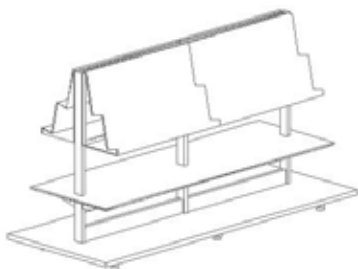

The configurations consist of the following components:

Component	Round corners Item no.	Quantity
Upright	B301000232	3
Crossbar	B3010129	4
Bottom shelf	B30850539225	1
Acrylic display shelf	B30850039	4
Shelf	B30850839225	1
Bracket for shelf	B3085043	6

Height 122 cm - 2 bays

Module 90 cm / depth 30 cm

Round corners
Configuration

Expo 40

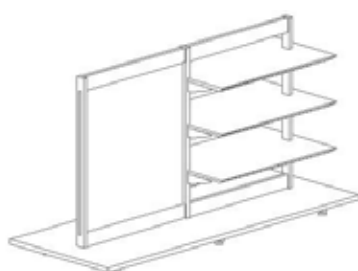

The configurations consist of the following components:

Component	Round corners Item no.	Quantity
Upright	B301000232	3
Crossbar	B3010129	4
Back panel	B301900295	1
Bottom shelf	B30850539225	1
Shelf	B30851139214	3
Bracket for shelf	B3085043	12

Height 122 cm - 2 bays

Module 90 cm / depth 30 cm

Round corners
Configuration

Expo 41

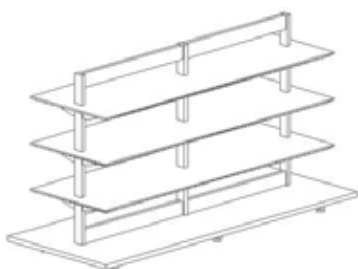

The configurations consist of the following components:

Component	Round corners Item no.	Quantity
Upright	B301000232	3
Crossbar	B3010129	4
Bottom shelf	B30850539225	1
Shelf	B30850839225	3
Bracket for shelf	B3085043	18

60/30 EXPO

DOUBLE-SIDED - H122 CM - 3 BAYS

Height 122 cm - 3 bays

Module 90 cm / depth 30 cm

Round corners
Configuration

Expo 42

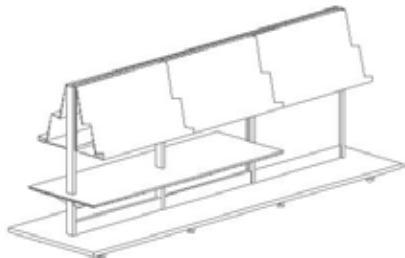

The configurations consist of the following components:

Component	Round corners Item no.	Quantity
Upright	B301000232	4
Crossbar	B3010129	6
Back panel	B301900295	1
Bottom shelf	B30850539235	1
Acrylic display shelf	B30850039	6
Shelf	B30851139224	1
Bracket for shelf	B3085043	6

Height 122 cm - 3 bays

Module 90 cm / depth 30 cm

Round corners
Configuration

Expo 43

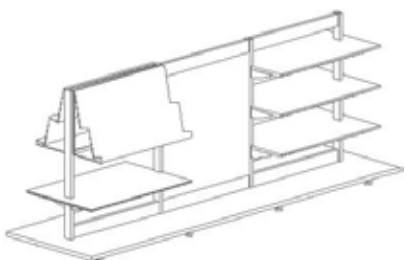

The configurations consist of the following components:

Component	Round corners Item no.	Quantity
Upright	B301000232	4
Crossbar	B3010129	6
Back panel	B301900295	1
Bottom shelf	B30850539235	1
Acrylic display shelf	B30850039	2
Shelf	B30851139224	4
Bracket for shelf	B3085043	16

Height 122 cm - 3 bays

Module 90 cm / depth 30 cm

Round corners
Configuration

Expo 44

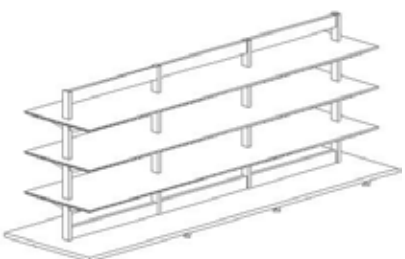

The configurations consist of the following components:

Component	Round corners Item no.	Quantity
Upright	B301000232	4
Crossbar	B3010129	6
Bottom shelf	B30850539235	1
Shelf	B30850839235	3
Bracket for shelf	B3085043	24

60/30 EXPO

DOUBLE-SIDED - H152 CM - 1 BAY

Height 152 cm - 1 bay

Module 90 cm / depth 30 cm

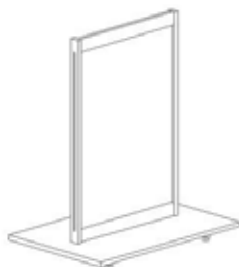

The configurations consist of the following components:

Component	Round corners Item no.	Quantity
Upright	B301000532	2
Crossbar	B3010129	2
Back panel	B301900595	1
Bottom shelf	B30850539215	1

Round corners Configuration

Expo 81

Height 152 cm - 1 bay

Module 90 cm / depth 30 cm

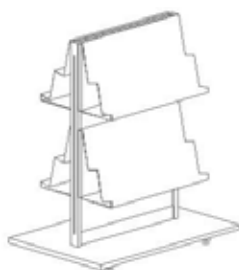

The configurations consist of the following components:

Component	Round corners Item no.	Quantity
Upright	B301000532	2
Crossbar	B3010129	2
Back panel	B301900595	1
Bottom shelf	B30850539215	1
Acrylic display shelf	B30850039	4

Round corners Configuration

Expo 82

Height 152 cm - 1 bay

Module 90 cm / depth 30 cm

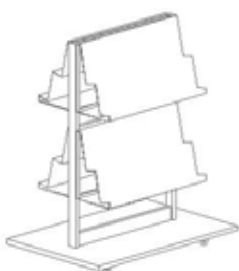

The configurations consist of the following components:

Component	Round corners Item no.	Quantity
Upright	B301000532	2
Crossbar	B3010129	2
Bottom shelf	B30850539215	1
Acrylic display shelf	B30850039	4

Round corners Configuration

Expo 83

Height 152 cm - 1 bay

Module 90 cm / depth 30 cm



The configurations consist of the following components:

Component	Round corners Item no.	Quantity
Upright	B301000532	2
Crossbar	B3010129	2
Bottom shelf	B30850539215	1
Acrylic display shelf	B30850039	2
Shelf	B30850839215	2
Bracket for shelf	B3085043	8

Round corners Configuration

Expo 84

60/30 EXPO

DOUBLE-SIDED - H152 CM - 1 & 2 BAYS

Height 152 cm - 1 bay

Module 90 cm / depth 30 cm

Round corners
Configuration

Expo 85



The configurations consist of the following components:

Component	Round corners Item no.	Quantity
Upright	B301000532	2
Crossbar	B3010129	2
Bottom shelf	B30850539215	1
Shelf	B30850839215	4
Bracket for shelf	B3085043	16

Height 152 cm - 2 bays

Module 90 cm / depth 30 cm

Round corners
Configuration

Expo 86

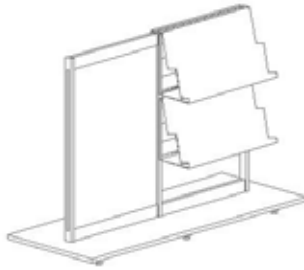

The configurations consist of the following components:

Component	Round corners Item no.	Quantity
Upright	B301000532	3
Crossbar	B3010129	4
Back panel	B301900595	1
Bottom shelf	B30850539225	1
Acrylic display shelf	B30850039	4

Height 152 cm - 2 bays

Module 90 cm / depth 30 cm

Round corners
Configuration

Expo 87

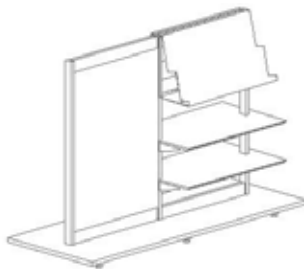

The configurations consist of the following components:

Component	Round corners Item no.	Quantity
Upright	B301000532	3
Crossbar	B3010129	4
Bottom shelf	B30850539225	1
Acrylic display shelf	B30850039	2
Shelf	B30851139214	2
Bracket for shelf	B3085043	8

Height 152 cm - 2 bays

Module 90 cm / depth 30 cm

Round corners
Configuration

Expo 88

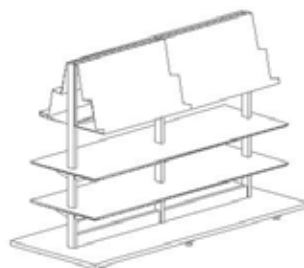

The configurations consist of the following components:

Component	Round corners Item no.	Quantity
Upright	B301000532	3
Crossbar	B3010129	4
Bottom shelf	B30850539225	1
Acrylic display shelf	B30850039	4
Shelf	B30850839225	2
Bracket for shelf	B3085043	12

60/30 EXPO

DOUBLE-SIDED - H152 CM - 2 & 3 BAYS

Height 152 cm - 2 bays

Module 90 cm / depth 30 cm

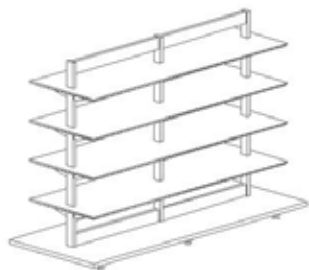

The configurations consist of the following components:

Component	Round corners Item no.	Quantity
Upright	B301000532	3
Crossbar	B3010129	4
Bottom shelf	B30850539225	1
Shelf	B30850839225	4
Bracket for shelf	B3085043	24

Round corners
Configuration

Expo 89

Height 152 cm - 3 bays

Module 90 cm / depth 30 cm

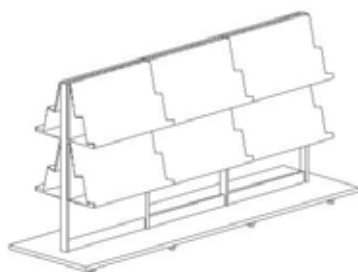

The configurations consist of the following components:

Component	Round corners Item no.	Quantity
Upright	B301000532	4
Crossbar	B3010129	6
Back panel	B301900595	1
Bottom shelf	B30850539235	1
Acrylic display shelf	B30850039	12

Round corners
Configuration

Expo 90

Height 152 cm - 3 bays

Module 90 cm / depth 30 cm

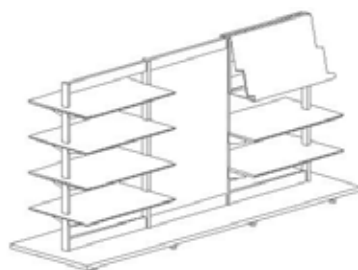

The configurations consist of the following components:

Component	Round corners Item no.	Quantity
Upright	B301000532	4
Crossbar	B3010129	6
Back panel	B301900595	1
Bottom shelf	B30850539235	1
Acrylic display shelf	B30850039	2
Shelf	B30851139214	6
Bracket for shelf	B3085043	24

Round corners
Configuration

Expo 91

Height 152 cm - 3 bays

Module 90 cm / depth 30 cm

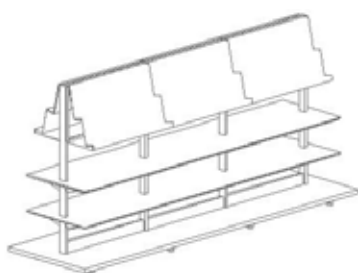

The configurations consist of the following components:

Component	Round corners Item no.	Quantity
Upright	B301000532	4
Crossbar	B3010129	6
Bottom shelf	B30850539235	1
Acrylic display shelf	B30850039	6
Shelf	B30850839235	2
Bracket for shelf	B3085043	16

Round corners
Configuration

Expo 92

SHELVES

S1 & S2 STEEL SHELVES

See below for overview of standard steel shelves:

B401001 - S1 STEEL SHELF WITH STEEL BACKEDGE - FOR BACKEDGE BOOK SUPPORT

Details:

- Module 750/900/1000 mm
- Depth 225/250/300/400 mm
- Steel backedge H47 mm
- Backedge book support
- Steel plate brackets
- Max. weight 80 kg.
- Straight, 45°/60° sloping & 7,5° reverse tilted
- Use with steel top shelf B401003, B401011, B301049, B301049 and wooden top shelf B401020

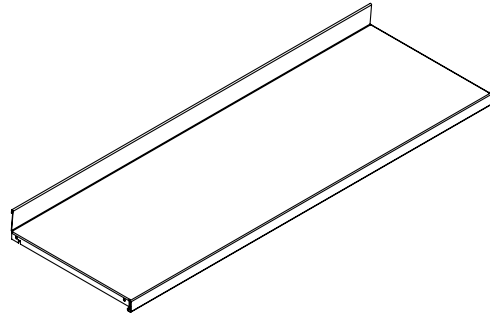

B401013 - S2 STEEL SHELF WITH ACRYLIC BACKEDGE - FOR HANGING BOOK SUPPORT

Details:

- Module 750/900/1000 mm
- Depth 225/250/300/400 mm
- Acrylic backedge H17 mm (loose part)
- Hanging book support
- Steel plate brackets
- Max. weight 80 kg.
- Straight, 45°/60° sloping & 7,5° reverse tilted
- Use with steel top shelf B401005

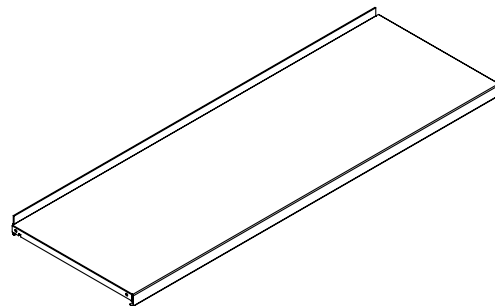

See below for overview of standard steel bottom shelves:

B301410 - BOTTOM STEEL SHELF WITH PLINTH

Details:

- Module 750/900/1000 mm
- Depth 225/250/300/400 mm
- Steel backedge H47 mm
- Steel brackets
- Max. weight 80 kg.
- Use with steel shelf B401001, steel top shelf B401003, B401011, B301049, B301049, and wooden top shelf B401020

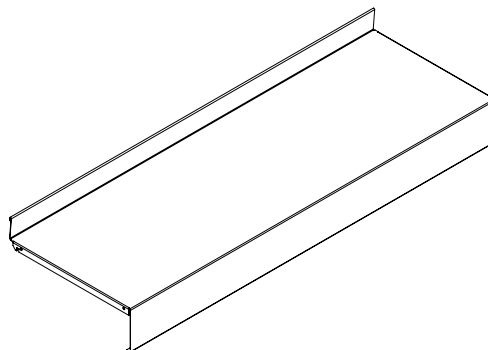

SHELVES

S1 STEEL SHELF WITH STEEL BACKEDGE

S1 steel shelf with steel backedge and steel brackets - for backedge book support

Steel backedge H47 mm. Incl. H15 cm brackets. Shelves for starter bays include left and right brackets. Shelves for add-on bays include double bracket.

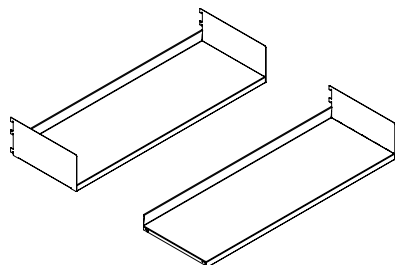

Module cm	Shelf depth cm	Item no. Starter bay	Item no. Add-on bay
75	22.5	BB4007621117	BB4007622117
75	25	BB4007621127	BB4007622127
75	30	BB4007621137	BB4007622137
75	40	BB4007621147	BB4007622147
90	22.5	BB4007621119	BB4007622119
90	25	BB4007621129	BB4007622129
90	30	BB4007621139	BB4007622139
90	40	BB4007621149	BB4007622149
100	22.5	BB4007621111	BB4007622111
100	25	BB4007621121	BB4007622121
100	30	BB4007621131	BB4007622131
100	40	BB4007621141	BB4007622141

S1 steel shelf with steel frontedge and 45°/60° steel plate brackets

Steel backedge H47 mm. Incl. left and right brackets.

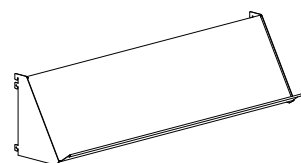

Module cm	Shelf depth cm	Item no. 45°	Item no. 60°
75	22.5	BB301201745	BB301201760
75	25	BB301202745	BB301202760
75	30	BB301203745	BB301203760
90	22.5	BB301201945	BB301201960
90	25	BB301202945	BB301202960
90	30	BB301203945	BB301203960
100	22.5	BB301201145	BB301201160
100	25	BB301202145	BB301202160
100	30	BB301203145	BB301203160

S1 steel shelf with steel backedge and 7.5° reverse tilted steel plate brackets

Steel backedge H47 mm. Incl. left and right brackets.

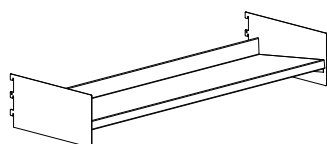

Module cm	Shelf depth cm	Dimension W X H cm	Item no.
75	22.5	25 x 15	BB30122174
75	22.5	30 x 15	BB30122171
75	25	30 x 15	BB30122275
75	30	35 x 20	BB30122372
75	30	40 x 15	BB30122376
75	30	40 x 20	BB30122373
90	22.5	25 x 15	BB30122194
90	22.5	30 x 15	BB30122191
90	25	30 x 15	BB30122295
90	30	35 x 20	BB30122392
90	30	40 x 15	BB30122396
90	30	40 x 20	BB30122393
100	22.5	25 x 15	BB30122114
100	22.5	30 x 15	BB30122111
100	25	30 x 15	BB30122215
100	30	35 x 20	BB30122312
100	30	40 x 15	BB30122316
100	30	40 x 20	BB30122313

SHELVES

S1 STEEL SHELF WITH STEEL BACKEDGE

S1 steel shelf with steel backedge - for backedge book support

Steel backedge H47 mm. Left, right or double brackets must be ordered separately. See page 72.

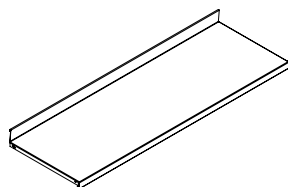

Module cm	Shelf depth cm	Item no.
75	22.5	B40100117
75	25	B40100127
75	30	B40100137
75	40	B40100147
90	22.5	B40100119
90	25	B40100129
90	30	B40100139
90	40	B40100149
100	22.5	B40100111
100	25	B40100121
100	30	B40100131
100	40	B40100141

Backedge book support - for S1 steel shelf

Nickel plated steel, Ø6 mm, with a nylon glider.

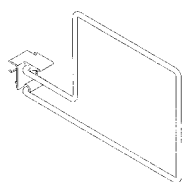

Height cm	Shelf depth cm	Type	Item no.
16,3	22.5/25	For books on left side of book support	B4011221
16,3	30	For books on left side of book support	B4011222
24,3	25/30	For books on left side of book support	B4011223
16,3	22.5/25	For books on right side of book support	B4011224
16,3	30	For books on right side of book support	B4011225

SHELVES

S2 STEEL SHELF WITH ACRYLIC BACKEDGE

S2 steel shelf with acrylic backedge and steel brackets - for hanging book support

Acrylic backedge H17 mm. Shelves for starter bays include left and right brackets. Shelves for add-on bays include double bracket. Note: Spot welding visible on top of surface.

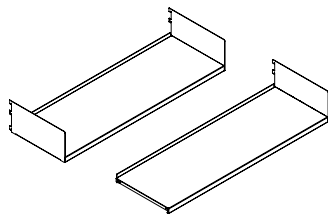

Module cm	Shelf depth cm	Item no. Starter bay	Item no. Add-on bay
75	22.5	BB4007721117	BB4007722117
75	25	BB4007721127	BB4007722127
75	30	BB4007721137	BB4007722137
75	40	BB4007721147	BB4007722147
90	22.5	BB4007721119	BB4007722119
90	25	BB4007721129	BB4007722129
90	30	BB4007721139	BB4007722139
90	40	BB4007721149	BB4007722149
100	22.5	BB4007721111	BB4007722111
100	25	BB4007721121	BB4007722121
100	30	BB4007721131	BB4007722131
100	40	BB4007721141	BB4007722141

S2 steel shelf with acrylic backedge and 45°/60° steel plate brackets

Acrylic backedge H17 mm. Incl. left and right brackets. Note: Spot welding visible on top of surface.

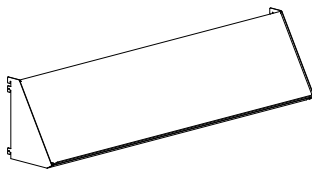

Module cm	Shelf depth cm	Item no. 45°	Item no. 60°
75	22.5	BB301241745	BB301241760
75	25	BB301242745	BB301242760
75	30	BB301243745	BB301243760
90	22.5	BB301241945	BB301241960
90	25	BB301242945	BB301242960
90	30	BB301243945	BB301243960
100	22.5	BB301241145	BB301241160
100	25	BB301242145	BB301242160
100	30	BB301243145	BB301243160

S2 steel shelf with acrylic backedge and 7.5° reverse tilted steel plate brackets

Acrylic backedge H17 mm. Incl. left and right brackets. Note: Spot welding visible on top of surface.

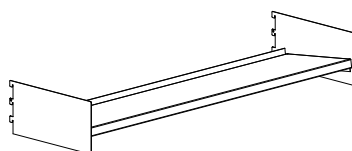

Module cm	Shelf depth cm	Dimension W X H cm	Item no.
75	22.5	25 x 15	BB30126174
75	22.5	30 x 15	BB30126171
75	25	30 x 15	BB30126275
75	30	35 x 20	BB30126372
75	30	40 x 15	BB30126376
75	30	40 x 20	BB30126373
90	22.5	25 x 15	BB30126194
90	22.5	30 x 15	BB30126191
90	25	30 x 15	BB30126295
90	30	35 x 20	BB30126392
90	30	40 x 15	BB30126396
90	30	40 x 20	BB30126393
100	22.5	25 x 15	BB30126114
100	22.5	30 x 15	BB30126111
100	25	30 x 15	BB30126215
100	30	35 x 20	BB30126312
100	30	40 x 15	BB30126316
100	30	40 x 20	BB30126313

SHELVES

S2 STEEL SHELF WITH ACRYLIC BACKEDGE

S2 steel shelf with acrylic backedge - for hanging book support

Acrylic backedge 17 mm. Left, right or double brackets must be ordered separately. See page 72. Note: Spot welding visible on top of surface.

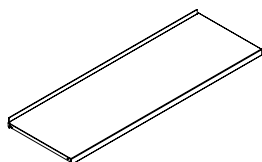

Module cm	Shelf depth cm	Item no.
75	22.5	B40101317
75	25	B40101327
75	30	B40101337
75	40	B40101347
90	22.5	B40101319
90	25	B40101329
90	30	B40101339
90	40	B40101349
100	22.5	B40101311
100	25	B40101321
100	30	B40101331
100	40	B40101341

Hanging book support - for S2

Available in chromed steel or standard steel colours.



Height cm	Item no.
20	B4011242
25	B4011245

SHELVES

BRACKETS FOR S1 & S2

Steel plate bracket for S1 & S2

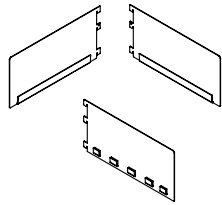

Type	Shelf depth cm	Item no. H15 cm	Item no. H20 cm
Left	22,5	B30101417	B30102017
Left	25	B30101427	B30102027
Left	30	B30101437	B30102037
Left	40	B30101447	B30102047
Right	22,5	B30101418	B30102018
Right	25	B30101428	B30102028
Right	30	B30101438	B30102038
Right	40	B30101448	B30102048
Double	22,5	B30101419	
Double	25	B30101429	
Double	30	B30101439	
Double	40	B30101449	

45°/60° steel plate bracket - for S1 & S2

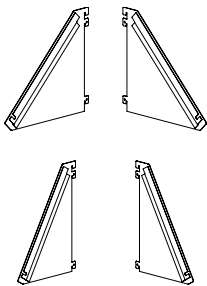

Depth cm	Degree	Item no. Left	Item no. Right
22.5	45°	B3010321458	B3010321459
25	45°	B3010322458	B3010322459
30	45°	B3010323458	B3010323459
22.5	60°	B3010321608	B3010321609
25	60°	B3010322608	B3010322609
30	60°	B3010323608	B3010323609

7.5° reverse tilted steel plate bracket - for S1 & S2

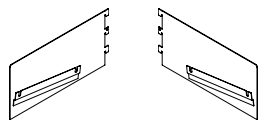

Shelf depth cm	Dimension W X H cm	Item no. Left	Item no. Right
22.5	25 x 15	B30114048	B30114049
22.5	30 x 15	B30114018	B30114019
25	30 x 15	B30114058	B30114059
30	35 x 20	B30114028	B30114029
30	40 x 15	B30114068	B30114069
30	40 x 20	B30114038	B30114039

Steel brackets for various shelf depths - for S1 & S2

Brackets for shelves with shorter depth than actual shelving system. This places the shelf in line with the front of shelving system.

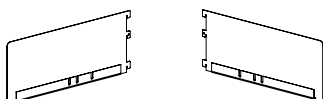

Depth cm	For shelving depths cm	Item no. Left	Item no. Right
25	22.5	B30102628	B30102629
30	22.5, 25	B30102638	B30102639
40	22.5, 25, 30	B30102648	B30102649

SHELVES

STEEL BOTTOM SHELF WITH BACKEDGE AND INTEGRATED PLINTH

Steel bottom shelf with steel backedge and integrated plinth - for backedge book support

Steel backedge H47 mm, integrated plinth H92 mm. Brackets must be ordered separately. See below. Does not fit Classic Steel 80/30.

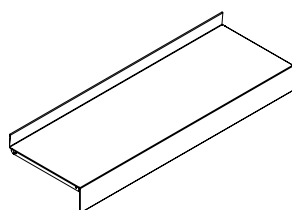

Module cm	Shelf depth cm	Item no.
75	22.5	B30141017
75	25	B30141027
75	30	B30141037
75	40	B30141047
90	22.5	B30141019
90	25	B30141029
90	30	B30141039
90	40	B30141049
100	22.5	B30141011
100	25	B30141021
100	30	B30141031
100	40	B30141041

Steel plate brackets for steel bottom shelf with steel backedge and integrated plinth

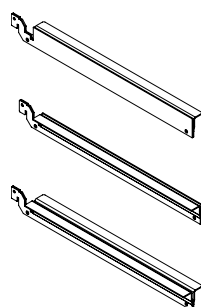

Type	Shelf depth cm	Item no.
Left	22.5	B30141417
Left	25	B30141427
Left	30	B30141437
Left	40	B30141447
Right	22.5	B30141418
Right	25	B30141428
Right	30	B30141438
Right	40	B30141448
Double	22.5	B30141419
Double	25	B30141429
Double	30	B30141439
Double	40	B30141449

SHELVES

SINGLE-SIDED STEEL TOP SHELVES

See below for overview of standard steel top shelves:

B401003 - SINGLE-SIDED STEEL TOP SHELF - 25 MM FRONTEDGE

Details:

- Module 750/900/1000 mm
- Depth 225/250/300/400 mm
- Steel brackets
- Max. weight 25 kg.
- Use with steel shelves with steel backedge for backedge book support

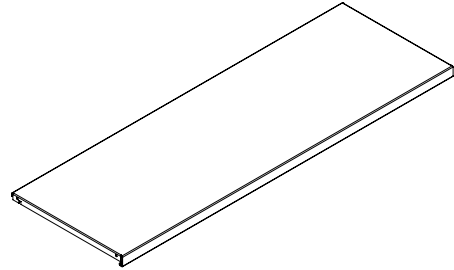

B401005 - SINGLE-SIDED STEEL TOP SHELF - SIGN PROFILE

Details:

- Module 750/900/1000 mm
- Depth 225/250/300/400 mm
- Steel brackets
- Max. weight 25 kg.
- Use with steel shelves with steel backedge for backedge book support

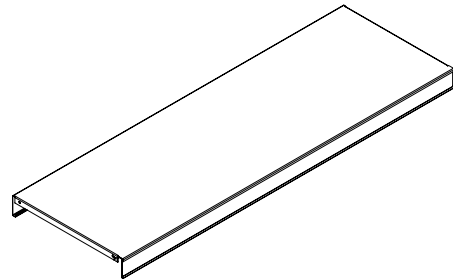

B401011 - SINGLE-SIDED STEEL TOP SHELF - 25 MM FRONTEDGE

Details:

- Module 750/900/1000 mm
- Depth 250/300/400 mm
- Steel brackets
- Max. weight 25 kg.
- Use with steel shelves with acrylic backedge for hanging book support

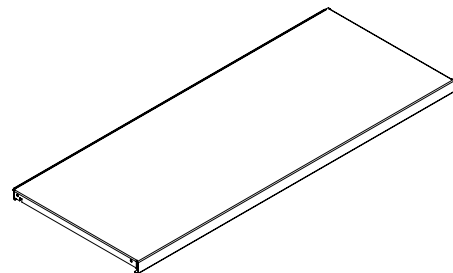

SHELVES

SINGLE- & DOUBLE-SIDED STEEL TOP SHELVES & LONDON TOP PLATE

See below for overview of standard steel top shelves:

B301049 - SINGLE-SIDED STEEL TOP SHELF - 25/47 MM FRONTEDGE

Details:

- Module 750/900/1000 mm
- Depth 225/250/300/400 mm
- Steel brackets
- Max. weight 25 kg.
- 1/2 bays
- Use with steel shelves with steel backedge for backedge book support

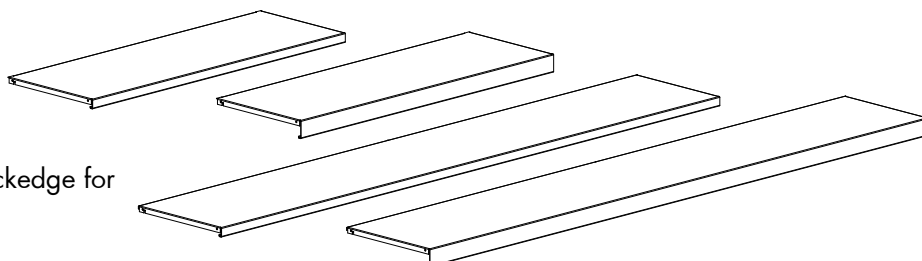

B301046 - DOUBLE-SIDED STEEL TOP SHELF - 25/47 MM FRONTEDGE

Details:

- Module 750/900/1000 mm
- Depth 225/250/300/400 mm
- Freestanding/outer/intermediate
- Steel brackets
- Max. weight 25 kg.
- 1/2 bays
- Use with steel shelves with steel backedge for backedge book support

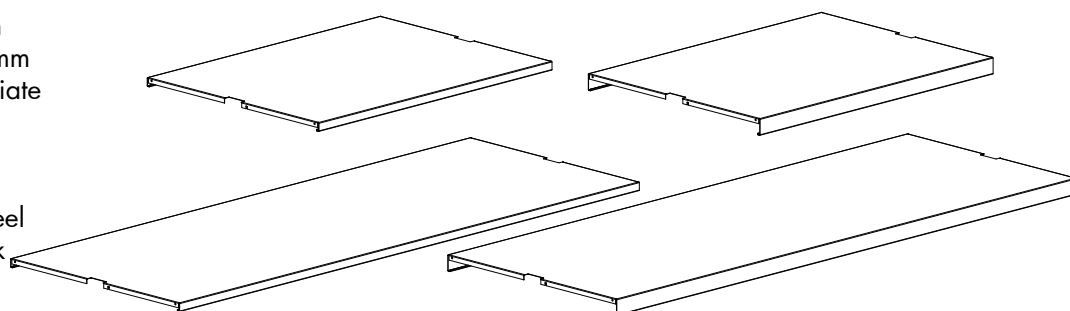

B301628 - SINGLE-SIDED LONDON STEEL TOP PLATE - 30 MM FRONTEDGE

Details:

- Module 750/900/1000 mm
- Depth 225/250/300/400 mm
- Freestanding/outer/intermediate
- Steel brackets
- Max. weight 25 kg.
- 1/2 bays

B301628 - DOUBLE-SIDED LONDON STEEL TOP PLATE - 30 MM FRONTEDGE

Details:

- Module 750/900/1000 mm
- Depth 225/250/300/400 mm
- Freestanding/outer/intermediate
- Steel brackets
- Max. weight 25 kg.
- 1/2 bays

SHELVES

SINGLE-SIDED STEEL TOP SHELVES - 25 MM FRONTEDGE - FOR BACKEDGE BOOK SUPPORT

Steel top shelf with brackets - to be used with steel shelves for backedge book support

Incl. H7.5 cm brackets. Top shelves for starter bays include left and right brackets. Top shelves for add-on bays include double bracket.

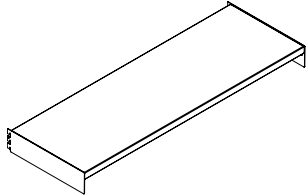

Module cm	Shelf depth cm	Item no. Starter bay	Item no. Add-on bay
75	22.5	BB4007621217	BB4007622217
75	25	BB4007621227	BB4007622227
75	30	BB4007621237	BB4007622237
75	40	BB4007621247	BB4007622247
90	22.5	BB4007621219	BB4007622219
90	25	BB4007621229	BB4007622229
90	30	BB4007621239	BB4007622239
90	40	BB4007621249	BB4007622249
100	22.5	BB4007621211	BB4007622211
100	25	BB4007621221	BB4007622221
100	30	BB4007621231	BB4007622231
100	40	BB4007621241	BB4007622241

Steel top shelf without brackets - to be used with steel shelves for backedge book support

Brackets must be ordered separately. A top shelf for starter bays must have a left and a right bracket. Top shelves for add-on bays must have a double bracket. See below.

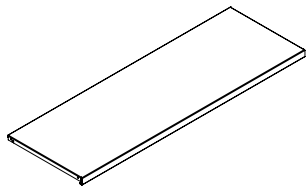

Module cm	Shelf depth cm	Item no.
75	22.5	B40100317
75	25	B40100327
75	30	B40100337
75	40	B40100347
90	22.5	B40100319
90	25	B40100329
90	30	B40100339
90	40	B40100349
100	22.5	B40100311
100	25	B40100321
100	30	B40100331
100	40	B40100341

Steel bracket for steel top shelf

H7.5 cm. Max. load of 25 kg.

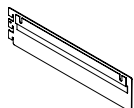
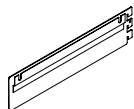

Type	Shelf depth cm	Item no.
Left	22.5	B30102417
Left	25	B30102427
Left	30	B30102437
Left	40	B30102447
Right	22.5	B30102418
Right	25	B30102428
Right	30	B30102438
Right	40	B30102448
Double	22.5	B30102419
Double	25	B30102429
Double	30	B30102439
Double	40	B30102449

SHELVES

SINGLE-SIDED STEEL TOP SHELVES - SIGN PROFILE - FOR BACKEDGE BOOK SUPPORT

Steel top shelf with sign profile and brackets - to be used with steel shelves for backedge book support

Incl. brackets. Label B401130 to be ordered separately. Top shelves for starter bays include left and right brackets. Top shelves for add-on bays include double bracket.

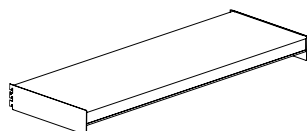

Module cm	Shelf depth cm	Item no. Starter bay	Item no. Add-on bay
75	22.5	BB400752117	BB400752217
75	25	BB400752127	BB400752227
75	30	BB400752137	BB400752237
75	40	BB400752147	BB400752247
90	22.5	BB400752119	BB400752219
90	25	BB400752129	BB400752229
90	30	BB400752139	BB400752239
90	40	BB400752149	BB400752249
100	22.5	BB400752111	BB400752211
100	25	BB400752121	BB400752221
100	30	BB400752131	BB400752231
100	40	BB400752141	BB400752241

Steel top shelf with sign profile without brackets - to be used with steel shelves for backedge book support

Brackets and label B401130 must be ordered separately. A top shelf for starter bays must have a left and a right bracket. Top shelves for add-on bays must have a double bracket. See below.

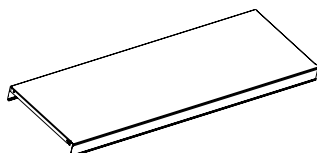

Module cm	Shelf depth cm	Item no.
75	22.5	B40100517
75	25	B40100527
75	30	B40100537
75	40	B40100547
90	22.5	B40100519
90	25	B40100529
90	30	B40100539
90	40	B40100549
100	22.5	B40100511
100	25	B40100521
100	30	B40100531
100	40	B40100541

Steel bracket for steel top shelf

H7.5 cm. Max. load of 25 kg.

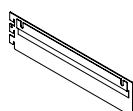
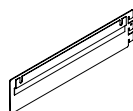

Type	Shelf depth cm	Item no.
Left	22.5	B30102417
Left	25	B30102427
Left	30	B30102437
Left	40	B30102447
Right	22.5	B30102418
Right	25	B30102428
Right	30	B30102438
Right	40	B30102448
Double	22.5	B30102419
Double	25	B30102429
Double	30	B30102439
Double	40	B30102449

SHELVES

SINGLE-SIDED STEEL TOP SHELVES - 25 MM FRONTEDGE - FOR HANGING BOOK SUPPORT

Steel top shelf with brackets - to be used with shelves for hanging book support

Incl. H7.5 cm lower brackets. Top shelves for starter bays include left and right brackets. Top shelves for add-on bays include double bracket.

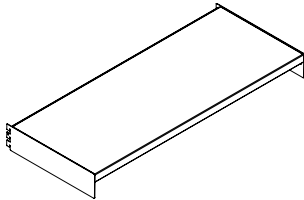

Module cm	Shelf depth cm	Item no. Starter bay	Item no. Add-on bay
75	22.5	BB4007721217	BB4007722217
75	25	BB4007721227	BB4007722227
75	30	BB4007721237	BB4007722237
75	40	BB4007721247	BB4007722247
90	22.5	BB4007721219	BB4007722219
90	25	BB4007721229	BB4007722229
90	30	BB4007721239	BB4007722239
90	40	BB4007721249	BB4007722249
100	22.5	BB4007721211	BB4007722211
100	25	BB4007721221	BB4007722221
100	30	BB4007721231	BB4007722231
1000	40	BB4007721241	BB4007722241

Steel top shelf without brackets - to be used with shelves for hanging book support

Brackets must be ordered separately. A top shelf for starter bays must have a left and a right bracket. Top shelves for add-on bays must have a double bracket. See below.

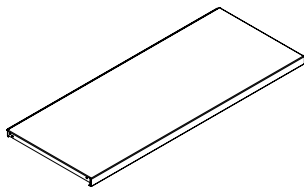

Module cm	Shelf depth cm	Item no.
75	22.5	B40101117
75	25	B40101127
75	30	B40101137
75	40	B40101147
90	22.5	B40101119
90	25	B40101129
90	30	B40101139
90	40	B40101149
100	22.5	B40101111
100	25	B40101121
100	30	B40101131
100	40	B40101141

Steel bracket for steel top shelf

H7.5 cm. Max. load of 25 kg.

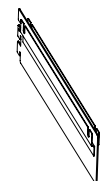
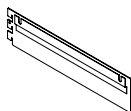
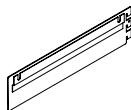



Type	Shelf depth cm	Item no.
Left	22.5	B30102417
Left	25	B30102427
Left	30	B30102437
Left	40	B30102447
Right	22.5	B30102418
Right	25	B30102428
Right	30	B30102438
Right	40	B30102448
Double	22.5	B30102419
Double	25	B30102429
Double	30	B30102439
Double	40	B30102449



SHELVES

SINGLE-SIDED STEEL TOP SHELF - 25 MM FRONTEDGE - WITH BRACKETS

Single-sided steel top shelf with brackets - to be used with steel shelves for backedge book support - for 1 bay

Incl. brackets. Top shelves for starter bays include left and right brackets. Top shelves for add-on bays include double bracket.	Module cm	Shelf depth cm	Item no. Starter bay	Item no. Add-on bay
 	75	22.5	BB30117171125	BB30117271125
	75	25	BB30117172125	BB30117272125
	75	30	BB30117173125	BB30117273125
	75	40	BB30117174125	BB30117274125
	90	22.5	BB30117191125	BB30117291125
	90	25	BB30117192125	BB30117292125
	90	30	BB30117193125	BB30117293125
	90	40	BB30117194125	BB30117294125
	100	22.5	BB30117111125	BB30117211125
	100	25	BB30117112125	BB30117212125
	100	30	BB30117113125	BB30117213125
	100	40	BB30117114125	BB30117214125

Single-sided steel top shelf with brackets - to be used with steel shelves for backedge book support - for 2 bays

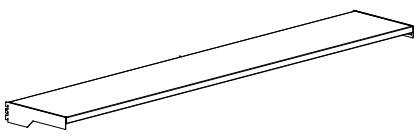
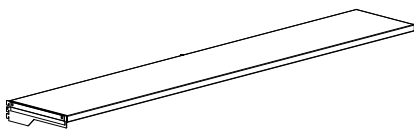
Incl. brackets. Top shelves for starter bays include left, middle and right brackets. Top shelves for add-on bays include middle and double bracket.	Module cm	Shelf depth cm	Item no. Starter bay	Item no. Add-on bay
 	75	22.5	BB30117171225	BB30117271225
	75	25	BB30117172225	BB30117272225
	75	30	BB30117173225	BB30117273225
	75	40	BB30117174225	BB30117274225
	90	22.5	BB30117191225	BB30117291225
	90	25	BB30117192225	BB30117292225
	90	30	BB30117193225	BB30117293225
	90	40	BB30117194225	BB30117294225
	100	22.5	BB30117111225	BB30117211225
	100	25	BB30117112225	BB30117212225
	100	30	BB30117113225	BB30117213225
	100	40	BB30117114225	BB30117214225

SHELVES

SINGLE-SIDED STEEL TOP SHELF - 25 MM FRONTEDGE

Single-sided steel top shelf without brackets - to be used with steel shelves for backedge book support - for 1 bay

Brackets must be ordered separately. A top shelf for starter bays must have a left and a right bracket. Top shelves for add-on bays must have a double bracket. See page 96.



Module cm	Shelf depth cm	Item no.
75	22.5	B30104971125
75	25	B30104972125
75	30	B30104973125
75	40	B30104974125
90	22.5	B30104991125
90	25	B30104992125
90	30	B30104993125
90	40	B30104994125
100	22.5	B30104911125
100	25	B30104912125
100	30	B30104913125
100	40	B30104914125

Single-sided steel top shelf without brackets - to be used with steel shelves for backedge book support - for 2 bays

Brackets must be ordered separately. A top shelf for starter bays must have a left, a middle and a right bracket. Top shelves for add-on bays must have a middle and a double bracket. See page 96.

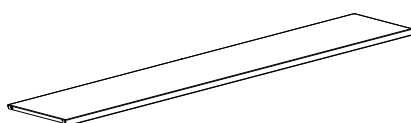

Module cm	Shelf depth cm	Item no.
75	22.5	B30104971225
75	25	B30104972225
75	30	B30104973225
75	40	B30104974225
90	22.5	B30104991225
90	25	B30104992225
90	30	B30104993225
90	40	B30104994225
100	22.5	B30104911225
100	25	B30104912225
100	30	B30104913225
100	40	B30104914225

SHELVES

SINGLE-SIDED STEEL TOP SHELF - 47 MM FRONTEDGE - WITH BRACKETS

Single-sided steel top shelf with brackets - to be used with steel shelves for backedge book support - for 1 bay

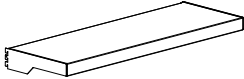
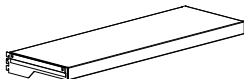
Incl. brackets. Top shelves for starter bays include left and right brackets. Top shelves for add-on bays include double bracket.	Module cm	Shelf depth cm	Item no. Starter bay	Item no. Add-on bay
 	75	22.5	BB30117171147	BB30117271147
	75	25	BB30117172147	BB30117272147
	75	30	BB30117173147	BB30117273147
	75	40	BB30117174147	BB30117274147
	90	22.5	BB30117191147	BB30117291147
	90	25	BB30117192147	BB30117292147
	90	30	BB30117193147	BB30117293147
	90	40	BB30117194147	BB30117294147
	100	22.5	BB30117111147	BB30117211147
	100	25	BB30117112147	BB30117212147
	100	30	BB30117113147	BB30117213147
	100	40	BB30117114147	BB30117214147

Single-sided steel top shelf with brackets - to be used with steel shelves for backedge book support - for 2 bays

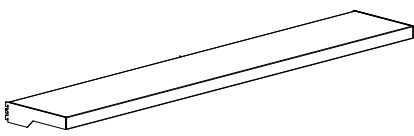
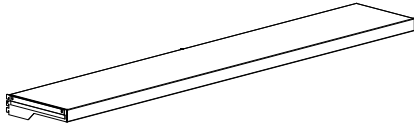
Incl. brackets. Top shelves for starter bays include left, middle and right brackets. Top shelves for add-on bays include middle and double bracket.	Module cm	Shelf depth cm	Item no. Starter bay	Item no. Add-on bay
 	75	22.5	BB30117171247	BB30117271247
	75	25	BB30117172247	BB30117272247
	75	30	BB30117173247	BB30117273247
	75	40	BB30117174247	BB30117274247
	90	22.5	BB30117191247	BB30117291247
	90	25	BB30117192247	BB30117292247
	90	30	BB30117193247	BB30117293247
	90	40	BB30117194247	BB30117294247
	100	22.5	BB30117111247	BB30117211247
	100	25	BB30117112247	BB30117212247
	100	30	BB30117113247	BB30117213247
	100	40	BB30117114247	BB30117214247

SHELVES

SINGLE-SIDED STEEL TOP SHELF - 47 MM FRONTEDGE

Single-sided steel top shelf without brackets - to be used with steel shelves for backedge book support - for 1 bay

Brackets must be ordered separately. A top shelf for starter bays must have a left and a right bracket. Top shelves for add-on bays must have a double bracket. See page 96.



Module cm	Shelf depth cm	Item no.
75	22.5	B30104971147
75	25	B30104972147
75	30	B30104973147
75	40	B30104974147
90	22.5	B30104991147
90	25	B30104992147
90	30	B30104993147
90	40	B30104994147
100	22.5	B30104911147
100	25	B30104912147
100	30	B30104913147
100	40	B30104914147

Single-sided steel top shelf without brackets - to be used with steel shelves for backedge book support - for 2 bays

Brackets must be ordered separately. A top shelf for starter bays must have a left, a middle and a right bracket. Top shelves for add-on bays must have a middle and a double bracket. See page 96.

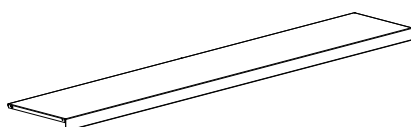

Module cm	Shelf depth cm	Item no.
75	22.5	B30104971247
75	25	B30104972247
75	30	B30104973247
75	40	B30104974247
90	22.5	B30104991247
90	25	B30104992247
90	30	B30104993247
90	40	B30104994247
100	22.5	B30104911247
100	25	B30104912247
100	30	B30104913247
100	40	B30104914247

SHELVES

DOUBLE-SIDED STEEL TOP SHELVES - 25 MM FRONTEDGE - FREESTANDING - WITH BRACKETS

Double-sided steel top shelf with brackets - for 1 freestanding bay

2 left and 2 right brackets included.

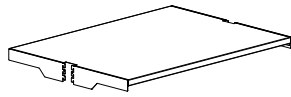

No. of bays	Frontedge cm	Module cm	Shelf depth cm	Item no.
1	25	75	22.5	BB30115719125
1	25	75	25	BB30115729125
1	25	75	30	BB30115739125
1	25	75	40	BB30115749125
1	25	90	22.5	BB30115919125
1	25	90	25	BB30115929125
1	25	90	30	BB30115939125
1	25	90	40	BB30115949125
1	25	100	22.5	BB30115119125
1	25	100	25	BB30115129125
1	25	100	30	BB30115139125
1	25	100	40	BB30115149125

Double-sided steel top shelf with brackets - for 2 freestanding bays

2 left, 2 middle and 2 right brackets included.

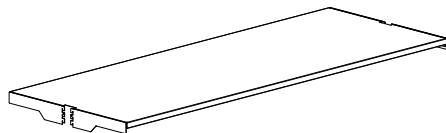

No. of bays	Frontedge cm	Module cm	Shelf depth cm	Item no.
2	25	75	22.5	BB30115719225
2	25	75	25	BB30115729225
2	25	75	30	BB30115739225
2	25	75	40	BB30115749225
2	25	90	22.5	BB30115919225
2	25	90	25	BB30115929225
2	25	90	30	BB30115939225
2	25	90	40	BB30115949225
2	25	100	22.5	BB30115119225
2	25	100	25	BB30115129225
2	25	100	30	BB30115139225
2	25	100	40	BB30115149225

SHELVES

DOUBLE-SIDED STEEL TOP SHELVES - 25 MM FRONTEDGE - FREESTANDING

Double-sided steel top shelf without brackets - for 1 freestanding bay

2 left and 2 right brackets must be ordered separately. See page 96.

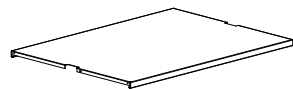

No. of bays	Frontedge cm	Module cm	Shelf depth cm	Item no.
1	25	75	22.5	B301046719125
1	25	75	25	B301046729125
1	25	75	30	B301046739125
1	25	75	40	B301046749125
1	25	90	22.5	B301046919125
1	25	90	25	B301046929125
1	25	90	30	B301046939125
1	25	90	40	B301046949125
1	25	100	22.5	B301046119125
1	25	100	25	B301046129125
1	25	100	30	B301046139125
1	25	100	40	B301046149125

Double-sided steel top shelf without brackets - for 2 freestanding bays

2 left, 2 middle and 2 right brackets must be ordered separately. See page 96.

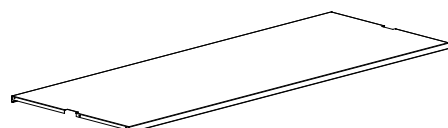

No. of bays	Frontedge cm	Module cm	Shelf depth cm	Item no.
2	25	75	22.5	B301046719225
2	25	75	25	B301046729225
2	25	75	30	B301046739225
2	25	75	40	B301046749225
2	25	90	22.5	B301046919225
2	25	90	25	B301046929225
2	25	90	30	B301046939225
2	25	90	40	B301046949225
2	25	100	22.5	B301046119225
2	25	100	25	B301046129225
2	25	100	30	B301046139225
2	25	100	40	B301046149225

SHELVES

DOUBLE-SIDED STEEL TOP SHELVES - 25 MM FRONTEDGE - OUTER - WITH BRACKETS

Double-sided steel top shelf with brackets - for 1 outer bay

1 left, 1 right and 1 double bracket included.

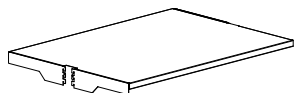

No. of bays	Frontedge cm	Module cm	Shelf depth cm	Item no.
1	25	75	22.5	BB30115718125
1	25	75	25	BB30115728125
1	25	75	30	BB30115738125
1	25	75	40	BB30115748125
1	25	90	22.5	BB30115918125
1	25	90	25	BB30115928125
1	25	90	30	BB30115938125
1	25	90	40	BB30115948125
1	25	100	22.5	BB30115118125
1	25	100	25	BB30115128125
1	25	100	30	BB30115138125
1	25	100	40	BB30115148125

Double-sided steel top shelf with brackets - for 2 outer bays

1 left, 1 right, 1 double and 2 middle brackets included.

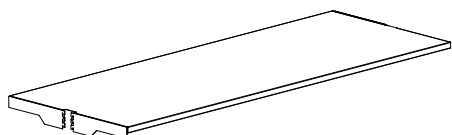

No. of bays	Frontedge cm	Module cm	Shelf depth cm	Item no.
2	25	75	22.5	BB30115718225
2	25	75	25	BB30115728225
2	25	75	30	BB30115738225
2	25	75	40	BB30115748225
2	25	90	22.5	BB30115918225
2	25	90	25	BB30115928225
2	25	90	30	BB30115938225
2	25	90	40	BB30115948225
2	25	100	22.5	BB30115118225
2	25	100	25	BB30115128225
2	25	100	30	BB30115138225
2	25	100	40	BB30115148225

SHELVES

DOUBLE-SIDED STEEL TOP SHELVES - 25 MM FRONTEDGE - OUTER

Double-sided steel top shelf without brackets - for 1 outer bay

1 left, 1 right and 1 double bracket must be ordered separately. See page 96.

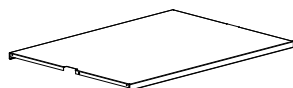

No. of bays	Frontedge cm	Module cm	Shelf depth cm	Item no.
1	25	75	22.5	B301046718125
1	25	75	25	B301046728125
1	25	75	30	B301046738125
1	25	75	40	B301046748125
1	25	90	22.5	B301046718147
1	25	90	25	B301046728147
1	25	90	30	B301046738147
1	25	90	40	B301046748147
1	25	100	22.5	B301046918125
1	25	100	25	B301046928125
1	25	100	30	B301046938125
1	25	100	40	B301046948125

Double-sided steel top shelf without brackets - for 2 outer bays

1 left, 1 right, 1 double and 2 middle brackets must be ordered separately. See page 96.

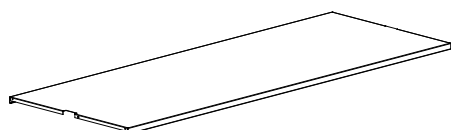

No. of bays	Frontedge cm	Module cm	Shelf depth cm	Item no.
2	25	75	22.5	B301046718225
2	25	75	25	B301046728225
2	25	75	30	B301046738225
2	25	75	40	B301046748225
2	25	90	22.5	B301046718247
2	25	90	25	B301046728247
2	25	90	30	B301046738247
2	25	90	40	B301046748247
2	25	100	22.5	B301046918225
2	25	100	25	B301046928225
2	25	100	30	B301046938225
2	25	100	40	B301046948225

SHELVES

DOUBLE-SIDED STEEL TOP SHELVES - 25 MM FRONTEDGE - INTERMEDIATE - WITH BRACKETS

Double-sided steel top shelf with brackets - for 1 intermediate bay

2 double brackets included.

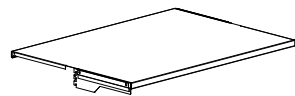

No. of bays	Frontedge cm	Module cm	Shelf depth cm	Item no.
1	25	75	22.5	BB30115717125
1	25	75	25	BB30115727125
1	25	75	30	BB30115737125
1	25	75	40	BB30115747125
1	25	90	22.5	BB30115917125
1	25	90	25	BB30115927125
1	25	90	30	BB30115937125
1	25	90	40	BB30115947125
1	25	100	22.5	BB30115117125
1	25	100	25	BB30115127125
1	25	100	30	BB30115137125
1	25	100	40	BB30115147125

Double-sided steel top shelf with brackets - for 2 intermediate bays

2 double and 2 middle brackets included.

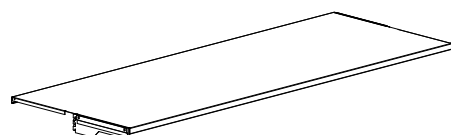

No. of bays	Frontedge cm	Module cm	Shelf depth cm	Item no.
2	25	75	22.5	BB30115717225
2	25	75	25	BB30115727225
2	25	75	30	BB30115737225
2	25	75	40	BB30115747225
2	25	90	22.5	BB30115917225
2	25	90	25	BB30115927225
2	25	90	30	BB30115937225
2	25	90	40	BB30115947225
2	25	100	22.5	BB30115117225
2	25	100	25	BB30115127225
2	25	100	30	BB30115137225
2	25	100	40	BB30115147225

SHELVES

DOUBLE-SIDED STEEL TOP SHELVES - 25 MM FRONTEDGE - INTERMEDIATE

Double-sided steel top shelf without brackets - for 1 intermediate bay

2 double brackets must be ordered separately. See page 96.

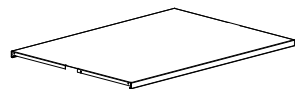

No. of bays	Frontedge cm	Module cm	Shelf depth cm	Item no.
1	25	75	22.5	B301046717125
1	25	75	25	B301046727125
1	25	75	30	B301046737125
1	25	75	40	B301046747125
1	25	90	22.5	B301046917125
1	25	90	25	B301046927125
1	25	90	30	B301046937125
1	25	90	40	B301046947125
1	25	100	22.5	B301046117125
1	25	100	25	B301046127125
1	25	100	30	B301046137125
1	25	100	40	B301046147125

Double-sided steel top shelf without brackets - for 2 intermediate bays

2 double and 2 middle brackets must be ordered separately. See page 96.

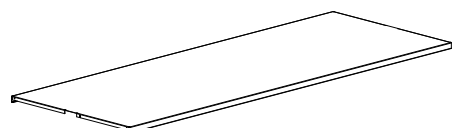

No. of bays	Frontedge cm	Module cm	Shelf depth cm	Item no.
2	25	75	22.5	B301046717225
2	25	75	25	B301046727225
2	25	75	30	B301046737225
2	25	75	40	B301046747225
2	25	90	22.5	B301046917225
2	25	90	25	B301046927225
2	25	90	30	B301046937225
2	25	90	40	B301046947225
2	25	100	22.5	B301046117225
2	25	100	25	B301046127225
2	25	100	30	B301046137225
2	25	100	40	B301046147225

SHELVES

DOUBLE-SIDED STEEL TOP SHELVES - 47 MM FRONTEDGE - FREESTANDING - WITH BRACKETS

Double-sided steel top shelf with brackets - for 1 freestanding bay

2 left and 2 right brackets included.

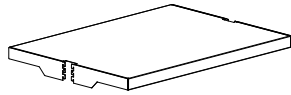

No. of bays	Frontedge cm	Module cm	Shelf depth cm	Item no.
1	47	75	22.5	BB30115719147
1	47	75	25	BB30115729147
1	47	75	30	BB30115739147
1	47	75	40	BB30115749147
1	47	90	22.5	BB30115919147
1	47	90	25	BB30115929147
1	47	90	30	BB30115939147
1	47	90	40	BB30115949147
1	47	100	22.5	BB30115119147
1	47	100	25	BB30115129147
1	47	100	30	BB30115139147
1	47	100	40	BB30115149147

Double-sided steel top shelf with brackets - for 2 freestanding bays

2 left, 2 middle and 2 right brackets included.

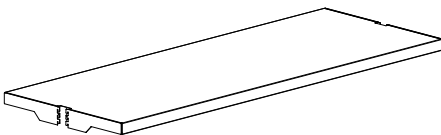

No. of bays	Frontedge cm	Module cm	Shelf depth cm	Item no.
2	47	75	22.5	BB30115719247
2	47	75	25	BB30115729247
2	47	75	30	BB30115739247
2	47	75	40	BB30115749247
2	47	90	22.5	BB30115919247
2	47	90	25	BB30115929247
2	47	90	30	BB30115939247
2	47	90	40	BB30115949247
2	47	100	22.5	BB30115119247
2	47	100	25	BB30115129247
2	47	100	30	BB30115139247
2	47	100	40	BB30115149247

SHELVES

DOUBLE-SIDED STEEL TOP SHELVES - 47 MM FRONTEDGE - FREESTANDING

Double-sided steel top shelf without brackets - for 1 freestanding bay

2 left and 2 right brackets must be ordered separately. See page 96.

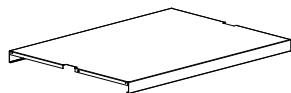

No. of bays	Frontedge cm	Module cm	Shelf depth cm	Item no.
1	47	75	22.5	B301046719147
1	47	75	25	B301046729147
1	47	75	30	B301046739147
1	47	75	40	B301046749147
1	47	90	22.5	B301046919147
1	47	90	25	B301046929147
1	47	90	30	B301046939147
1	47	90	40	B301046949147
1	47	100	22.5	B301046119147
1	47	100	25	B301046129147
1	47	100	30	B301046139147
1	47	100	40	B301046149147

Double-sided steel top shelf without brackets - for 2 freestanding bays

2 left, 2 middle and 2 right brackets must be ordered separately. See page 96.

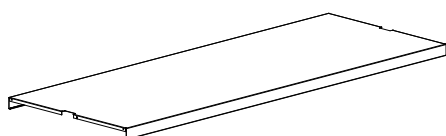

No. of bays	Frontedge cm	Module cm	Shelf depth cm	Item no.
2	47	75	22.5	B301046719247
2	47	75	25	B301046729247
2	47	75	30	B301046739247
2	47	75	40	B301046749247
2	47	90	22.5	B301046919247
2	47	90	25	B301046929247
2	47	90	30	B301046939247
2	47	90	40	B301046949247
2	47	100	22.5	B301046119247
2	47	100	25	B301046129247
2	47	100	30	B301046139247
2	47	100	40	B301046149247

SHELVES

DOUBLE-SIDED STEEL TOP SHELVES - 47 MM FRONTEDGE - OUTER - WITH BRACKETS

Double-sided steel top shelf with brackets - for 1 outer bay

1 left, 1 right and 1 double bracket included.

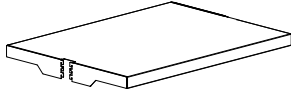

No. of bays	Frontedge cm	Module cm	Shelf depth cm	Item no.
1	47	75	22.5	BB30115718147
1	47	75	25	BB30115728147
1	47	75	30	BB30115738147
1	47	75	40	BB30115748147
1	47	90	22.5	BB30115918147
1	47	90	25	BB30115928147
1	47	90	30	BB30115938147
1	47	90	40	BB30115948147
1	47	100	22.5	BB30115118147
1	47	100	25	BB30115128147
1	47	100	30	BB30115138147
1	47	100	40	BB30115148147

Double-sided steel top shelf with brackets - for 2 outer bays

1 left, 1 right, 1 double and 2 middle brackets included.

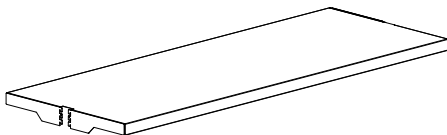

No. of bays	Frontedge cm	Module cm	Shelf depth cm	Item no.
2	47	75	22.5	BB30115718247
2	47	75	25	BB30115728247
2	47	75	30	BB30115738247
2	47	75	40	BB30115748247
2	47	90	22.5	BB30115918247
2	47	90	25	BB30115928247
2	47	90	30	BB30115938247
2	47	90	40	BB30115948247
2	47	100	22.5	BB30115118247
2	47	100	25	BB30115128247
2	47	100	30	BB30115138247
2	47	100	40	BB30115148247

SHELVES

DOUBLE-SIDED STEEL TOP SHELVES - 47 MM FRONTEDGE - OUTER

Double-sided steel top shelf without brackets - for 1 outer bay

1 left, 1 right and 1 double bracket must be ordered separately. See page 96.

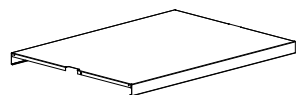

No. of bays	Frontedge cm	Module cm	Shelf depth cm	Item no.
1	47	75	22.5	B301046718147
1	47	75	25	B301046728147
1	47	75	30	B301046738147
1	47	75	40	B301046748147
1	47	90	22.5	B301046918147
1	47	90	25	B301046928147
1	47	90	30	B301046938147
1	47	90	40	B301046948147
1	47	100	22.5	B301046118147
1	47	100	25	B301046128147
1	47	100	30	B301046138147
1	47	100	40	B301046148147

Double-sided steel top shelf without brackets - for 2 outer bays

1 left, 1 right, 1 double and 2 middle brackets must be ordered separately. See page 96.

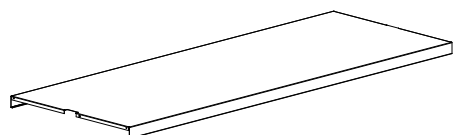

No. of bays	Frontedge cm	Module cm	Shelf depth cm	Item no.
2	47	75	22.5	B301046718247
2	47	75	25	B301046728247
2	47	75	30	B301046738247
2	47	75	40	B301046748247
2	47	90	22.5	B301046918247
2	47	90	25	B301046928247
2	47	90	30	B301046938247
2	47	90	40	B301046948247
2	47	100	22.5	B301046118247
2	47	100	25	B301046128247
2	47	100	30	B301046138247
2	47	100	40	B301046148247

SHELVES

DOUBLE-SIDED STEEL TOP SHELVES - 47 MM FRONTEDGE - INTERMEDIATE - WITH BRACKETS

Double-sided steel top shelf with brackets - for 1 intermediate bay

2 double brackets included.

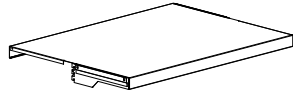

No. of bays	Frontedge cm	Module cm	Shelf depth cm	Item no.
1	47	75	22.5	BB30115717147
1	47	75	25	BB30115727147
1	47	75	30	BB30115737147
1	47	75	40	BB30115747147
1	47	90	22.5	BB30115917147
1	47	90	25	BB30115927147
1	47	90	30	BB30115937147
1	47	90	40	BB30115947147
1	47	100	22.5	BB30115117147
1	47	100	25	BB30115127147
1	47	100	30	BB30115137147
1	47	100	40	BB30115147147

Double-sided steel top shelf with brackets - for 2 intermediate bays

2 double and 2 middle brackets included.

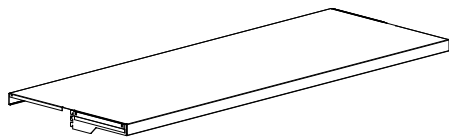

No. of bays	Frontedge cm	Module cm	Shelf depth cm	Item no.
2	47	75	22.5	BB30115717247
2	47	75	25	BB30115727247
2	47	75	30	BB30115737247
2	47	75	40	BB30115747247
2	47	90	22.5	BB30115917247
2	47	90	25	BB30115927247
2	47	90	30	BB30115937247
2	47	90	40	BB30115947247
2	47	100	22.5	BB30115117247
2	47	100	25	BB30115127247
2	47	100	30	BB30115137247
2	47	100	40	BB30115147247

SHELVES

DOUBLE-SIDED STEEL TOP SHELVES - 47 MM FRONTEDGE - INTERMEDIATE

Double-sided steel top shelf without brackets - for 1 intermediate bay

2 double brackets must be ordered separately. See page 96.

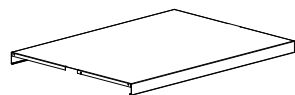

No. of bays	Frontedge cm	Module cm	Shelf depth cm	Item no.
1	47	75	22.5	B301046717147
1	47	75	25	B301046727147
1	47	75	30	B301046737147
1	47	75	40	B301046747147
1	47	90	22.5	B301046917147
1	47	90	25	B301046927147
1	47	90	30	B301046937147
1	47	90	40	B301046947147
1	47	100	22.5	B301046117147
1	47	100	25	B301046127147
1	47	100	30	B301046137147
1	47	100	40	B301046147147

Double-sided steel top shelf without brackets - for 2 intermediate bays

2 double and 2 middle brackets must be ordered separately. See page 96.

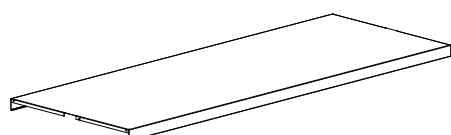



No. of bays	Frontedge cm	Module cm	Shelf depth cm	Item no.
2	47	75	22.5	B301046717247
2	47	75	25	B301046727247
2	47	75	30	B301046737247
2	47	75	40	B301046747247
2	47	90	22.5	B301046917247
2	47	90	25	B301046927247
2	47	90	30	B301046937247
2	47	90	40	B301046947247
2	47	100	22.5	B301046117247
2	47	100	25	B301046127247
2	47	100	30	B301046137247
2	47	100	40	B301046147247

SHELVES

BRACKETS FOR STEEL TOP SHELVES

Steel bracket for steel top shelf B301046 and B301049

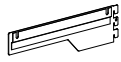
Max. load of 25 kg.

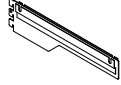
	Type	Shelf depth cm	Item no.
	Left	22.5	B30102917
	Left	25	B30102927
	Left	30	B30102937
	Left	40	B30102947
	Right	22.5	B30102918
	Right	25	B30102928
	Right	30	B30102938
	Right	40	B30102948
	Double	22.5	B30102919
	Double	25	B30102929
	Double	30	B30102939
	Double	40	B30102949

Steel middle bracket for steel top shelf B301046 and B301049 over 2 bays

Max. load of 25 kg.

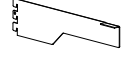
	Frontedge cm	Shelf depth cm	Item no.
	25	22.5	B301047125
	25	25	B301047225
	25	30	B301047325
	25	40	B301047425
	47	22.5	B301047147
	47	25	B301047247
	47	30	B301047347
	47	40	B301047447



SHELVES

SINGLE-SIDED LONDON STEEL OVERLAYING TOP PLATE - 30 MM FRONTEDGE

Single-sided London steel overlaying top plate - freestanding

30 mm front edge. Incl. brackets.	Module cm	Shelf depth cm	Bays	Art. no.
	75	22.5	1	B301628711019
	75	25	1	B301628721019
	75	30	1	B301628731019
	75	40	1	B301628741019
	90	22.5	1	B301628911019
	90	25	1	B301628921019
	90	30	1	B301628931019
	90	40	1	B301628941019
	100	22.5	1	B301628111019
	100	25	1	B301628121019
	100	30	1	B301628131019
	100	40	1	B301628141019
	75	22.5	2	B301628711029
	75	25	2	B301628721029
	75	30	2	B301628731029
	75	40	2	B301628741029
	90	22.5	2	B301628911029
	90	25	2	B301628921029
	90	30	2	B301628931029
	90	40	2	B301628941029
	100	22.5	2	B301628111029
	100	25	2	B301628121029
	100	30	2	B301628131029
	100	40	2	B301628141029

Single-sided London steel overlaying top plate - outer

30 mm front edge. Incl. brackets.	Module cm	Shelf depth cm	Bays	Art. no.
	75	22.5	1	B301628711017
	75	25	1	B301628721017
	75	30	1	B301628731017
	75	40	1	B301628741017
	90	22.5	1	B301628911017
	90	25	1	B301628921017
	90	30	1	B301628931017
	90	40	1	B301628941017
	100	22.5	1	B301628111017
	100	25	1	B301628121017
	100	30	1	B301628131017
	100	40	1	B301628141017
	75	22.5	2	B301628711027
	75	25	2	B301628721027
	75	30	2	B301628731027
	75	40	2	B301628741027
	90	22.5	2	B301628911027
	90	25	2	B301628921027
	90	30	2	B301628931027
	90	40	2	B301628941027
	100	22.5	2	B301628111027
	100	25	2	B301628121027
	100	30	2	B301628131027
	100	40	2	B301628141027

SHELVES

SINGLE-SIDED LONDON STEEL OVERLAYING TOP PLATE - 30 MM FRONTEDGE

Single-sided London steel overlaying top plate - intermediate

30 mm front edge. Incl. brackets.	Module cm	Shelf depth cm	Bays	Art. no.
	75	22.5	1	B301628711018
	75	25	1	B301628721018
	75	30	1	B301628731018
	75	40	1	B301628741018
	90	22.5	1	B301628911018
	90	25	1	B301628921018
	90	30	1	B301628931018
	90	40	1	B301628941018
	100	22.5	1	B301628111018
	100	25	1	B301628121018
	100	30	1	B301628131018
	100	40	1	B301628141018
	75	22.5	2	B301628711028
	75	25	2	B301628721028
	75	30	2	B301628731028
	75	40	2	B301628741028
	90	22.5	2	B301628911028
	90	25	2	B301628921028
	90	30	2	B301628931028
	90	40	2	B301628941028
	100	22.5	2	B301628111028
	100	25	2	B301628121028
	100	30	2	B301628131028
	100	40	2	B301628141028

SHELVES

DOUBLE-SIDED LONDON STEEL OVERLAYING TOP PLATE - 30 MM FRONTEDGE

Double-sided London steel overlaying top plate - freestanding

30 mm front edge. Incl. brackets.	Module cm	Shelf depth cm	Bays	Art. no.
	75	22.5	1	B301628712019
	75	25	1	B301628722019
	75	30	1	B301628732019
	75	40	1	B301628742019
	90	22.5	1	B301628912019
	90	25	1	B301628922019
	90	30	1	B301628932019
	90	40	1	B301628942019
	100	22.5	1	B301628112019
	100	25	1	B301628122019
	100	30	1	B301628132019
	100	40	1	B301628142019
	75	22.5	2	B301628712029
	75	25	2	B301628722029
	75	30	2	B301628732029
	75	40	2	B301628742029
	90	22.5	2	B301628912029
	90	25	2	B301628922029
	90	30	2	B301628932029
	90	40	2	B301628942029
	100	22.5	2	B301628112029
	100	25	2	B301628122029
	100	30	2	B301628132029
	100	40	2	B301628142029

Double-sided London steel overlaying top plate - outer

30 mm front edge. Incl. brackets.	Module cm	Shelf depth cm	Bays	Art. no.
	75	22.5	1	B301628712017
	75	25	1	B301628722017
	75	30	1	B301628732017
	75	40	1	B301628742017
	90	22.5	1	B301628912017
	90	25	1	B301628922017
	90	30	1	B301628932017
	90	40	1	B301628942017
	100	22.5	1	B301628112017
	100	25	1	B301628122017
	100	30	1	B301628132017
	100	40	1	B301628142017
	75	22.5	2	B301628712027
	75	25	2	B301628722027
	75	30	2	B301628732027
	75	40	2	B301628742027
	90	22.5	2	B301628912027
	90	25	2	B301628922027
	90	30	2	B301628932027
	90	40	2	B301628942027
	100	22.5	2	B301628112027
	100	25	2	B301628122027
	100	30	2	B301628132027
	100	40	2	B301628142027

SHELVES

DOUBLE-SIDED LONDON STEEL OVERLAYING TOP PLATE - 30 MM FRONTEDGE

Double-sided London steel overlaying top plate - intermediate

30 mm front edge. Incl. brackets.	Module cm	Shelf depth cm	Bays	Art. no.
	75	22.5	1	B301628712018
	75	25	1	B301628722018
	75	30	1	B301628732018
	75	40	1	B301628742018
	90	22.5	1	B301628912018
	90	25	1	B301628922018
	90	30	1	B301628932018
	90	40	1	B301628942018
	100	22.5	1	B301628112018
	100	25	1	B301628122018
	100	30	1	B301628132018
	100	40	1	B301628142018
	75	22.5	2	B301628712028
	75	25	2	B301628722028
	75	30	2	B301628732028
	75	40	2	B301628742028
	90	22.5	2	B301628912028
	90	25	2	B301628922028
	90	30	2	B301628932028
	90	40	2	B301628942028
	100	22.5	2	B301628112028
	100	25	2	B301628122028
	100	30	2	B301628132028
	100	40	2	B301628142028

SHELVES

WOODEN SHELVES

See below for overview of standard wooden shelves:

B401020 - WOODEN SHELF WITH STEEL BACKEDGE

Details:

- Module 750/900 mm
- Depth 225/250/300/400 mm
- Steel backedge H47 mm
- Backedge book support
- Steel plate brackets
- Max. weight 80 kg.
- Straight
- Use with steel top shelf B401003, B401011, B301049, B301049 and wooden top shelf B401020

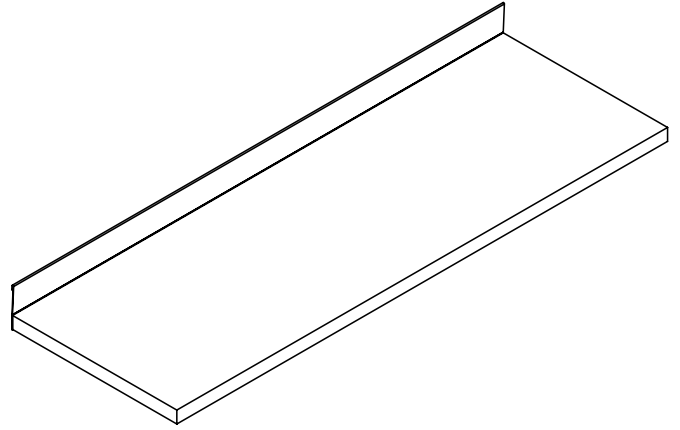

SHELVES

WOODEN SHELVES

Wooden shelf with steel backedge and without brackets - for backedge book support

Brackets must be ordered separately.
See below.

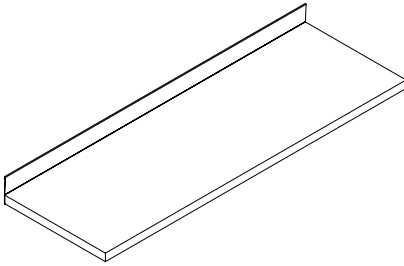

Module cm	Shelf depth cm	Item no. Painted	Item no. Veneer
75	22.5	B4010201175	B4010201171
75	25	B4010201275	B4010201271
75	30	B4010201375	B4010201371
75	40	B4010201475	B4010201471
90	22.5	B4010201195	B4010201191
90	25	B4010201295	B4010201291
90	30	B4010201395	B4010201391
90	40	B4010201495	B4010201491

Steel plate bracket for wooden shelf

H15 cm. For both starter and add-on bays, one left bracket and one right bracket are needed.

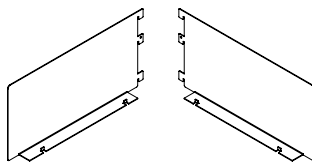

Type	Shelf depth cm	Item no.
Left	22.5	B30110618
Left	25	B30110628
Left	30	B30110638
Left	40	B30110648
Right	22.5	B30110619
Right	25	B30110629
Right	30	B30110639
Right	40	B30110649

SHELVES

WOODEN TOP SHELVES AND LONDON OVERLAYING TOP PLATE

See below for overview of standard wooden top shelves and overlaying top plate:

B401020 - SINGLE-SIDED WOODEN TOP SHELF

Details:

- Module 750/900/1000 mm
- Depth 225/250/300/400 mm
- Steel brackets
- Max. weight 25 kg.

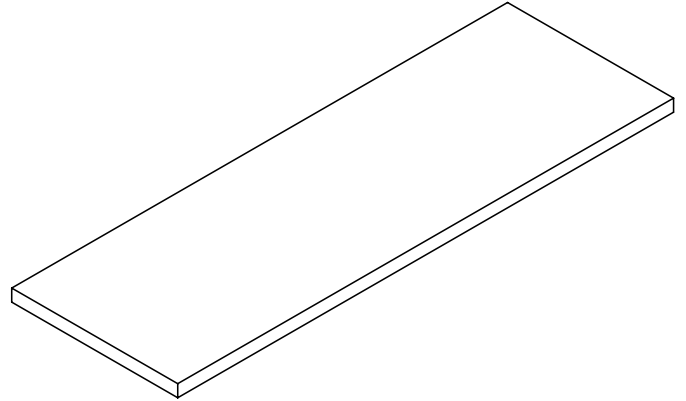

B302130 - FSC SINGLE- & DOUBLE-SIDED LONDON WOODEN OVERLAYING TOP PLATE

Details:

- Module 750/900/1000 mm
- Depth 225/250/300/400 mm
- Freestanding/outer/intermediate
- Steel brackets
- Max. weight 25 kg.
- 1/2/3 bays

SHELVES

WOODEN TOP SHELVES - FOR BACKEDGE BOOK SUPPORT

Wooden top shelf without brackets - to be used with steel shelves for backedge book support

Brackets must be ordered separately.
See below.

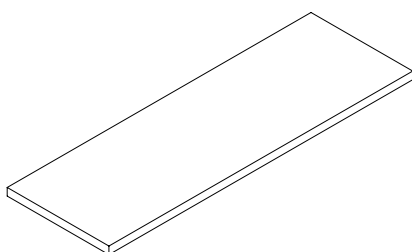

Module cm	Shelf depth cm	Item no. Painted	Item no. Veneer
75	22.5	B4010200175	B4010200171
75	25	B4010200275	B4010200271
75	30	B4010200375	B4010200371
75	40	B4010200475	B4010200471
90	22.5	B4010200195	B4010200191
90	25	B4010200295	B4010200291
90	30	B4010200395	B4010200391
90	40	B4010200495	B4010200491
100	22.5	B4010200115	B4010200111
100	25	B4010200215	B4010200211
100	30	B4010200315	B4010200311
100	40	B4010200415	B4010200411

Steel bracket for wooden top shelf

H7.5 cm. For both starter and add-on bays, one left bracket and one right bracket are needed.

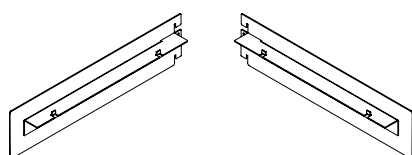

Type	Shelf depth cm	Item no.
Left	22.5	B30110018
Left	25	B30110028
Left	30	B30110038
Left	40	B30110048
Right	22.5	B30110019
Right	25	B30110029
Right	30	B30110039
Right	40	B30110049

SHELVES

SINGLE-SIDED LONDON WOODEN OVERLAYING TOP PLATES - FREESTANDING - WITH BRACKETS

Single-sided FSC London wooden overlaying top plate - freestanding

30 mm front edge. Incl. brackets.	Module cm	Shelf depth cm	Bays	Art. no.
	75	22.5	1	B302136171019
	75	25	1	B302136271019
	75	30	1	B302136371019
	75	40	1	B302136471019
	90	22.5	1	B302136191019
	90	25	1	B302136291019
	90	30	1	B302136391019
	90	40	1	B302136491019
	100	22.5	1	B302136111019
	100	25	1	B302136211019
	100	30	1	B302136311019
	100	40	1	B302136411019
	75	22.5	2	B302136171029
	75	25	2	B302136271029
	75	30	2	B302136371029
	75	40	2	B302136471029
	90	22.5	2	B302136191029
	90	25	2	B302136291029
	90	30	2	B302136391029
	90	40	2	B302136491029
	100	22.5	2	B302136111029
	100	25	2	B302136211029
	100	30	2	B302136311029
	100	40	2	B302136411029
	75	22.5	3	B302136171039
	75	25	3	B302136271039
	75	30	3	B302136371039
	75	40	3	B302136471039
	90	22.5	3	B302136191039
	90	25	3	B302136291039
	90	30	3	B302136391039
	90	40	3	B302136491039

SHELVES

SINGLE-SIDED LONDON WOODEN OVERLAYING TOP PLATES - OUTER - WITH BRACKETS

Single-sided FSC London wooden overlaying top plate - outer

30 mm front edge. Incl. brackets.	Module cm	Shelf depth cm	Bays	Art. no.
	75	22.5	1	B302136171017
	75	25	1	B302136271017
	75	30	1	B302136371017
	75	40	1	B302136471017
	90	22.5	1	B302136191017
	90	25	1	B302136291017
	90	30	1	B302136391017
	90	40	1	B302136491017
	100	22.5	1	B302136111017
	100	25	1	B302136211017
	100	30	1	B302136311017
	100	40	1	B302136411017
	75	22.5	2	B302136171027
	75	25	2	B302136271027
	75	30	2	B302136371027
	75	40	2	B302136471027
	90	22.5	2	B302136191027
	90	25	2	B302136291027
	90	30	2	B302136391027
	90	40	2	B302136491027
	100	22.5	2	B302136111027
	100	25	2	B302136211027
	100	30	2	B302136311027
	100	40	2	B302136411027
	75	22.5	3	B302136171037
	75	25	3	B302136271037
	75	30	3	B302136371037
	75	40	3	B302136471037
	90	22.5	3	B302136191037
	90	25	3	B302136291037
	90	30	3	B302136391037
	90	40	3	B302136491037

SHELVES

SINGLE-SIDED LONDON WOODEN OVERLAYING TOP PLATES - INTERMEDIATE - WITH BRACKETS

Single-sided FSC London wooden overlaying top plate - intermediate

30 mm front edge. Incl. brackets.

Module cm	Shelf depth cm	Bays	Art. no.
75	22.5	1	B302136171018
75	25	1	B302136271018
75	30	1	B302136371018
75	40	1	B302136471018
90	22.5	1	B302136191018
90	25	1	B302136291018
90	30	1	B302136391018
90	40	1	B302136491018
100	22.5	1	B302136111018
100	25	1	B302136211018
100	30	1	B302136311018
100	40	1	B302136411018
75	22.5	2	B302136171028
75	25	2	B302136271028
75	30	2	B302136371028
75	40	2	B302136471028
90	22.5	2	B302136191028
90	25	2	B302136291028
90	30	2	B302136391028
90	40	2	B302136491028
100	22.5	2	B302136111028
100	25	2	B302136211028
100	30	2	B302136311028
100	40	2	B302136411028
75	22.5	3	B302136171038
75	25	3	B302136271038
75	30	3	B302136371038
75	40	3	B302136471038
90	22.5	3	B302136191038
90	25	3	B302136291038
90	30	3	B302136391038
90	40	3	B302136491038

SHELVES

DOUBLE-SIDED LONDON WOODEN OVERLAYING TOP PLATES - FREESTANDING - WITH BRACKETS

Double-sided FSC London wooden overlaying top plate - freestanding

30 mm front edge. Incl. brackets.	Module cm	Shelf depth cm	Bays	Art. no.
	75	22.5	1	B302136172019
	75	25	1	B302136272019
	75	30	1	B302136372019
	75	40	1	B302136472019
	90	22.5	1	B302136192019
	90	25	1	B302136292019
	90	30	1	B302136392019
	90	40	1	B302136492019
	100	22.5	1	B302136112019
	100	25	1	B302136212019
	100	30	1	B302136312019
	100	40	1	B302136412019
	75	22.5	2	B302136172029
	75	25	2	B302136272029
	75	30	2	B302136372029
	75	40	2	B302136472029
	90	22.5	2	B302136192029
	90	25	2	B302136292029
	90	30	2	B302136392029
	90	40	2	B302136492029
	100	22.5	2	B302136112029
	100	25	2	B302136212029
	100	30	2	B302136312029
	100	40	2	B302136412029
	75	22.5	3	B302136172039
	75	25	3	B302136272039
	75	30	3	B302136372039
	75	40	3	B302136472039
	90	22.5	3	B302136192039
	90	25	3	B302136292039
	90	30	3	B302136392039
	90	40	3	B302136492039

SHELVES

DOUBLE-SIDED LONDON WOODEN OVERLAYING TOP PLATES - OUTER - WITH BRACKETS

Double-sided FSC London wooden overlaying top plate - outer

30 mm front edge. Incl. brackets.

Module cm	Shelf depth cm	Bays	Art. no.
75	22.5	1	B302136172017
75	25	1	B302136272017
75	30	1	B302136372017
75	40	1	B302136472017
90	22.5	1	B302136192017
90	25	1	B302136292017
90	30	1	B302136392017
90	40	1	B302136492017
100	22.5	1	B302136112017
100	25	1	B302136212017
100	30	1	B302136312017
100	40	1	B302136412017
75	22.5	2	B302136172027
75	25	2	B302136272027
75	30	2	B302136372027
75	40	2	B302136472027
90	22.5	2	B302136192027
90	25	2	B302136292027
90	30	2	B302136392027
90	40	2	B302136492027
100	22.5	2	B302136112027
100	25	2	B302136212027
100	30	2	B302136312027
100	40	2	B302136412027
75	22.5	3	B302136172037
75	25	3	B302136272037
75	30	3	B302136372037
75	40	3	B302136472037
90	22.5	3	B302136192037
90	25	3	B302136292037
90	30	3	B302136392037
90	40	3	B302136492037

SHELVES

DOUBLE-SIDED LONDON WOODEN OVERLAYING TOP PLATES - INTERMEDIATE - WITH BRACKETS

Double-sided FSC London wooden overlaying top plate - intermediate

30 mm front edge. Incl. brackets.

Module cm	Shelf depth cm	Bays	Art. no.
75	22.5	1	B302136172018
75	25	1	B302136272018
75	30	1	B302136372018
75	40	1	B302136472018
90	22.5	1	B302136192018
90	25	1	B302136292018
90	30	1	B302136392018
90	40	1	B302136492018
100	22.5	1	B302136112018
100	25	1	B302136212018
100	30	1	B302136312018
100	40	1	B302136412018
75	22.5	2	B302136172028
75	25	2	B302136272028
75	30	2	B302136372028
75	40	2	B302136472028
90	22.5	2	B302136192028
90	25	2	B302136292028
90	30	2	B302136392028
90	40	2	B302136492028
100	22.5	2	B302136112028
100	25	2	B302136212028
100	30	2	B302136312028
100	40	2	B302136412028
75	22.5	3	B302136172038
75	25	3	B302136272038
75	30	3	B302136372038
75	40	3	B302136472038
90	22.5	3	B302136192038
90	25	3	B302136292038
90	30	3	B302136392038
90	40	3	B302136492038

SHELVES

BRACKETS FOR LONDON WOODEN TOP PLATES

Steel top bracket for London wooden top plate

When sold separately, it is necessary to order two screws per bracket, item no. 1147024016.

Shelf depth cm
22.5
25
30
40

Item no. Left

B30120018
B30120028
B30120038
B30120048

Item no. Right

B30120019
B30120029
B30120039
B30120049

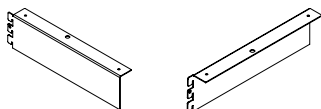

Reinforcement for shelf

All depths

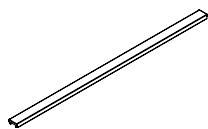

Module
cm

75
90
100

Item no.

B3020407
B3020409
B3020401

Acrylic backedge

For shelf BB40077xxxxx and
B401013xx.
H6 cm.

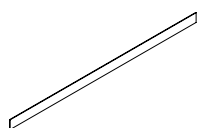

Module
cm

75
90
100

Item no.

B4010127
B4010129
B4010121

Shelf bridge for shelf without backedge for 60/30 & 80/30 Classic upright

Used to minimize gap between top
shelves without steel backedge and
without sign profile on double-sided
shelving. W6 cm for 60/30, W8 cm
for 80/30.

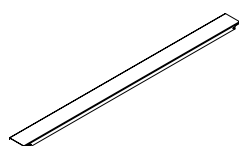

Module
cm

75
90
100

Width
cm

6
6
6

8
8
8

Item no.

B3020307
B3020309
B3020301

B3020357
B3020359
B3020351



Backedge book support for straight shelves with steel backedge

Nickel plated steel, Ø6 mm, with a nylon glider. For shelf BB40076xxxxx and B401001xx.

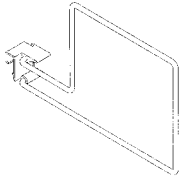

Height cm	Shelf depth cm	Type	Item no.
16,3	22.5/25	For books on left side of book support	B4011221
16,3	30	For books on left side of book support	B4011222
24,3	25/30	For books on left side of book support	B4011223
16,3	22.5/25	For books on right side of book support	B4011224
16,3	30	For books on right side of book support	B4011225

Hanging book support for shelves with acrylic backedge

Available in chromed steel or BCI standard steel colours. For shelf BB40077xxxxx and B401013xx



Height cm	Item no.
20	B4011242
25	B4011245

Rail for hanging book support for wooden shelves

Incl. fittings.

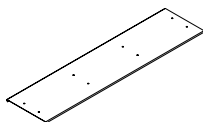

Width cm	Shelf depth cm	Item no.
75	25, 30, 40	B4022007
90	25, 30, 40	B4022009

Angled book support

W15 x H15 x D15 cm.

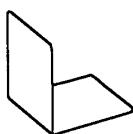

Item no.
B401120

ACCESSORIES

BROWSERS

Single steel browser - one level - without/with pull-out frame

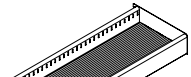
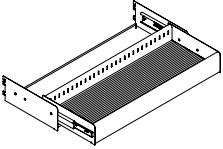
W75 cm. Incl. fittings and rubber mat. Excl. tubes	Height cm	Depth cm	No. of dividers	Item no.	
				Without pull-out function	With pull-out function
 	10	30 ^{*1}	0	B3052007100	B3052027500
	10	30	1	B3052007101	B3052027501
	10	30	2	B3052007102	B3052027502
	10	30	4	B3052007104	B3052027504

Single steel browser - one level - without/with pull-out frame

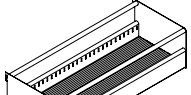
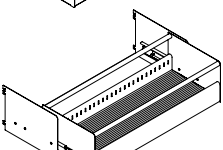
W75 cm. Incl. fittings, rubber mat and tubes.	Height cm	Depth cm	No. of dividers	Item no.	
				Without pull-out function	With pull-out function
 	20	30 ^{*2}	0	B3052007200	B3052027600
	20	30	1	B3052007201	B3052027601
	20	30	2	B3052007202	B3052027602
	20	30	4	B3052007204	B3052027604

Single steel browser - one level - without/with pull-out frame

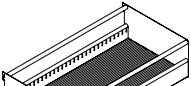
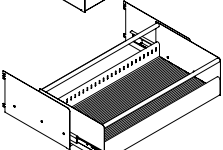
W75 cm. Incl. fittings, rubber mat and tubes.	Height cm	Depth cm	No. of dividers	Item no.	
				Without pull-out function	With pull-out function
 	20	40 ^{*3}	0	B3052007300	B3052027700
	20	40	1	B3052007301	B3052027701
	20	40	2	B3052007302	B3052027702
	20	40	4	B3052007304	B3052027704

Double steel browser - two levels - without/with pull-out frame

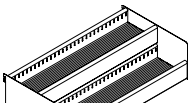
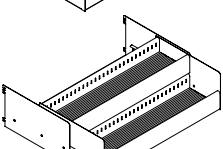
W75 cm. Incl. fittings and rubber mat. Excl. tubes	Height cm	Depth cm	No. of dividers	Item no.	
				Without pull-out function	With pull-out function
 	20	40 ^{*4}	0	B3052007400	B3052027800
	20	40	2	B3052007402	B3052027802
	20	40	4	B3052007404	B3052027804
	20	40	8	B3052007408	B3052027808

Single steel browser - one level - without/with pull-out frame

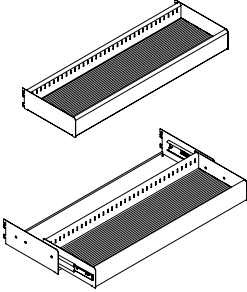
W90 cm. Incl. fittings and rubber mat. Excl. tubes	Height cm	Depth cm	No. of dividers	Item no.	
				Without pull-out function	With pull-out function
	10	30 ^{*1}	0	B3052009100	B3052029500
	10	30	2	B3052009101	B3052029501
	10	30	4	B3052009102	B3052029502
	10	30	5	B3052009104	B3052029504

Single steel browser - one level - without/with pull-out frame

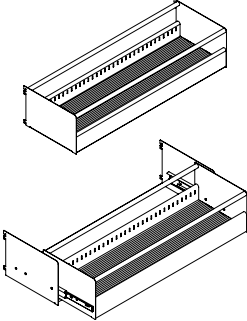
W90 cm. Incl. fittings, rubber mat and tubes.	Height cm	Depth cm	No. of dividers	Item no.	
				Without pull-out function	With pull-out function
	20	30 ^{*2}	0	B3052009200	B3052029600
	20	30	2	B3052009201	B3052029601
	20	30	4	B3052009202	B3052029602
	20	30	5	B3052009204	B3052029604

Single steel browser - one level - without/with pull-out frame

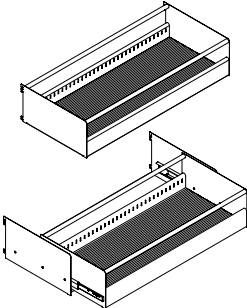
W90 cm. Incl. fittings, rubber mat and tubes.	Height cm	Depth cm	No. of dividers	Item no.	
				Without pull-out function	With pull-out function
	20	40 ^{*3}	0	B3052009300	B3052029700
	20	40	2	B3052009301	B3052029701
	20	40	4	B3052009302	B3052029702
	20	40	5	B3052009304	B3052029704

Double steel browser - two levels - without/with pull-out frame

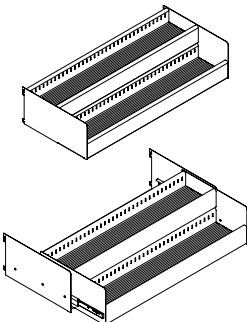
W90 cm. Incl. fittings and rubber mat. Excl. tubes	Height cm	Depth cm	No. of dividers	Item no.	
				Without pull-out function	With pull-out function
	20	40 ^{*4}	0	B3052009400	B3052029800
	20	40	4	B3052009402	B3052029802
	20	40	8	B3052009404	B3052029804
	20	40	10	B3052009408	B3052029808



WE
ARE
LIBRARY
PEOPLE®



ACCESSORIES

BROWSERS

Dividers for single and double steel browser

Chromed steel.

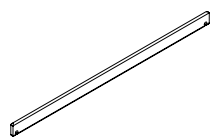

Level	Height cm	Depth cm
One	10	30
One	20	30
One	20	40
Two	20	40

Item no.

B4011603
B4011603
B4011604
B4011601

Capacity examples for 75 cm single/double steel browser without pullout (see page 116)

	Type	W cm	H x D cm	CD cases	DVD cases	CD pockets	Picture books	Comic picture books
				5 rows	5 rows	5 rows	3 rows	2 rows
*1	Single	75	10 x 30	100	75	325	-	-
*2	Single	75	20 x 30	100	75	325	90	40
*3	Single	75	20 x 40	150	105	325	120	50
				2 x 5 rows	2 x 5 rows	2 x 5 rows	3 rows	2 rows
*4	Double	75	20 x 40	130	95	400	-	-

Capacity examples for 75 cm single/double steel browser with pullout (see page 116)

	Type	W cm	H x D cm	CD cases	DVD cases	CD pockets	Picture books	Comic picture books
				5 rows	5 rows	5 rows	3 rows	2 rows
*1	Single	75 cm	10 x 30	80	60	260	-	-
*2	Single	75 cm	20 x 30	80	60	260	90	40
*3	Single	75 cm	20 x 40	120	84	340	120	50
				2 x 5 rows	2 x 5 rows	2 x 5 rows	3 rows	2 rows
*4	Double	75 cm	20 x 40	104	76	320	-	-

Capacity examples for 90 cm single/double steel browser without pullout (see page 117)

	Type	W cm	H x D cm	CD cases	DVD cases	CD pockets	Picture books	Comic picture books
				6 rows	6 rows	6 rows	4 rows	3 rows
*1	Single	90 cm	10 x 30	120	90	390	-	-
*2	Single	90 cm	20 x 30	120	90	390	120	60
*3	Single	90 cm	20 x 40	180	126	510	180	75
				2 x 6 rows	2 x 6 rows	2 x 6 rows	4 rows	3 rows
*4	Double	90 cm	20 x 40	156	114	480	-	-

Capacity examples for 90 cm single/double steel browser with pullout (see page 117)

	Type	W cm	H x D cm	CD cases	DVD cases	CD pockets	Picture books	Comic picture books
				6 rows	6 rows	6 rows	4 rows	3 rows
*1	Single	90 cm	10 x 30	100	75	325	-	-
*2	Single	90 cm	20 x 30	100	75	325	120	60
*3	Single	90 cm	20 x 40	150	105	425	160	75
				2 x 6 rows	2 x 6 rows	2 x 6 rows	4 rows	3 rows
*4	Double	90 cm	20 x 40	130	95	400	-	-



TIDNINGAR

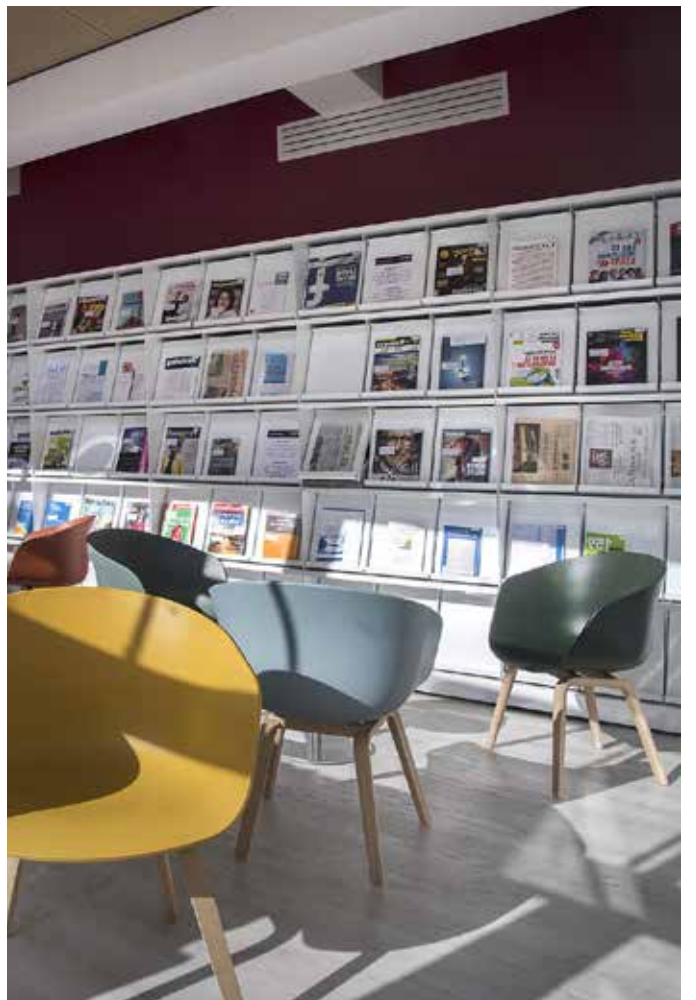

ACCESSORIES

DISPLAY & STORAGE - MAGAZINE

Magazine display - with 1 tip up sloping shelf

W90 x H40 x D40 cm. With space for storage of either magazines piled horizontally or vertical binders (up to 32 cm in height)

Item no.

B305100

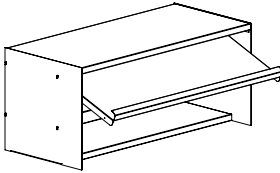

Magazine display - with 1 tip up sloping shelf and moveable dividers

W90 x H40 x D40 cm. With space for separate storage of either magazines piled horizontally or vertical binders (up to 32 cm in height). Dividers can be moved 5 cm either way.

Item no.

B305110

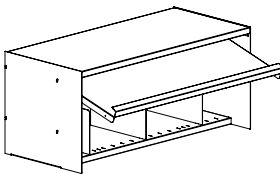

Magazine display - with 3 tip up sloping shelves

W90 x H40 x D40 cm. With space for separate storage of either magazines piled horizontally or vertical binders (up to 32 cm in height)

Item no.

B305120

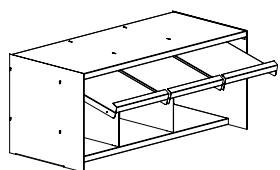



ACCESSORIES

DISPLAY & STORAGE - MAGAZINE

Steel magazine box - Unibox

H320 x D260 x W320 mm. Box and flap lacquered steel. With transparent antireflex foil. Recommended for use on D250 mm steel shelf with/without backedge and wooden shelf without backedge. Can be used on D300 mm shelves. With space for storage of magazines piled horizontally 140 mm.

Design	Back wall	Item no.
-	Yes	B405502001
-	No	B405502000
With holes	Yes	B405502051
With holes	No	B405502050
With slots	Yes	B405502101
With slots	No	B405502100

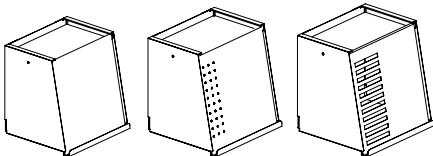

Steel magazine box

H320 x D260 x W238 mm. Box and flap lacquered steel. Recommended for use on D250 mm steel shelf with/without backedge and wooden shelf without backedge. Can be used on D300 mm shelves. Upright storage of magazines. With space for storage of magazines piled vertically 140 mm.

Item no.
B405504

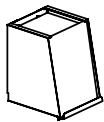

Steel cabinet with sliding door

W90 x D40 cm. Incl. lock and 1 shelf.

Height cm	Item no.
62.5	B3050306
80.0	B3050307

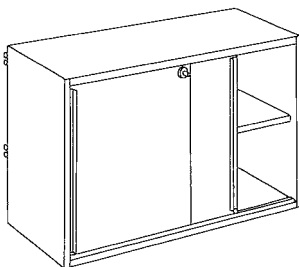



ACCESSORIES

DISPLAY & STORAGE - MULTIMEDIA

Steel pocket book shelf

W90 x H20 x D22.5 cm. Incl. fittings.
Capacity: 50-60 pcs.

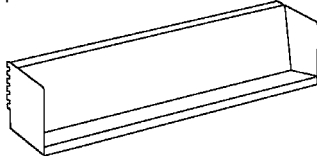

Item no.

B30515019

Steel shelf for CD's - 5 compartments (W17.8) with 4 steel dividers

W90 x H15 x D22.5 cm. Incl. fittings.
Capacity: 75 CD's

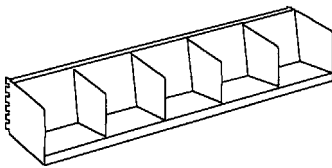

Item no.

B30513019

Steel shelf - 4 compartments (W22.4 cm) with 3 steel dividers

W90 x H20 cm. Incl. fittings.
Capacity: 75 picture books

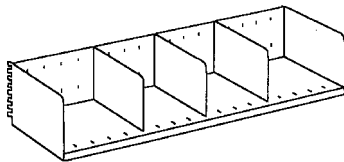

Depth
cm

22.5
30

Item no.

B3050411
B3050413

Extra steel dividers for steel shelf B305041x

H17.5 cm

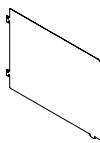

Depth
cm

22.5
30

Item no.

B4010401
B4010403

Steel shelf with 5 sliding dividers

W90 x H40 x D40 cm. Incl. fittings.
Can be used under browsers with
D40 cm on page 117. Capacity:
75 picture books/ 100 music
books.

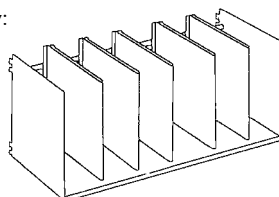

Item no.

B305080

FUNCTIONS

DISPLAY & STORAGE - FOR SHELVES

Steel magazine display

H300 mm. With slanted back and additional side stop. A double front edge keeps this collector flush with the front edge of the shelf. With slip stop to prevent the display from slipping on steel shelves.

Size	Width mm
DIN A4	220
DIN A3	440

Item no.	Price DKK
B4055064	-
B4055063	-

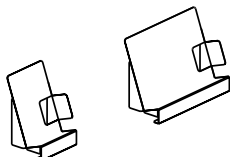

Steel magazine divider

H300 x W95 x D240 mm. Single, slanted element connectable side by side via plug-in connections. For bay W700 mm, use 6 dividers. For bay W900 mm, use 8 dividers. For bay W1000 mm, use 9 dividers.

Size
DIN A4

Item no.	Price DKK
B405508	-

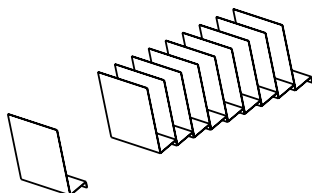

FUNCTIONS

DISPLAY & STORAGE - FOR SHELVES

Steel U-storage

H250 x W145 x D220 mm.
Multi-functional storage use.

Item no.

Price
DKK

B405510

-

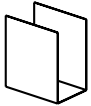

Steel slanted CD tray

H120 x W150 x D220 mm. With anti-slipping feet. Rubber mat to be ordered separately.

Approx. capacity

Item no.

Price
DKK

20 CD's
Rubber mat

B405536

-

B405538

-

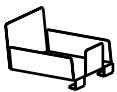

ACCESSORIES

DISPLAY & STORAGE - FOR WOODEN SLAT END PANEL

Acrylic media display holder

H100 x W600 x D40 mm.

Item no.

E34466

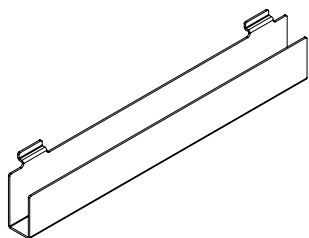

Acrylic brochure holder

H250 x W500 x D50 mm.

Item no.

E34467

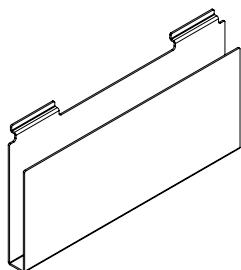

Acrylic sloping shelf display

H200 x W500 x D300 mm.

Item no.

E34468

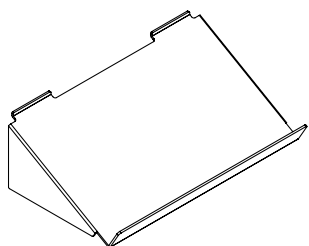

Acrylic tilted shelf display

H160 mm.

Width
mm

Depth
mm

Item no.

75
220

90
95

E34469
E34470

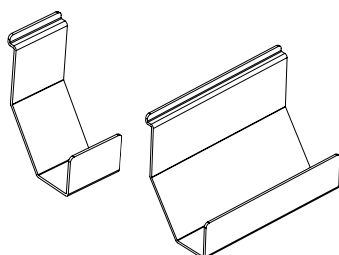

ACCESSORIES

DISPLAY & STORAGE - FOR PERFORATED STEEL END PANELS

Steel CD and paperback holder

The holder is a pair, so the width will vary. Bright galvanized steel.

Height mm	Max. insert size mm	Item no.
60	25	B4055221
140	25	B4055222

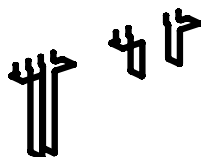

Steel book presenter

H148 x W90 mm. Chromed steel.

Size	Max. insert size mm	Item no.
A4	45	B405526



Steel hanging display

H200 x W90 mm. Chromed steel.

Size	Max. insert size mm	Item no.
A4	50	B405528





WE
ARE
LIBRARY
PEOPLE®



ACCESSORIES

SIGNAGE - FOR END PANEL/UPRIGHT/TOP

Steel sign for wooden end panel

Fastened to the end panel with screws.
The sign has an acrylic film for insertion
of textslide.

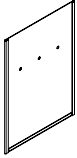

A4 vertical/upright format
A3 vertical/upright format
A3 horizontal format

Item no.

B40110377
B40110378
B40110379

Steel sign for 60/30 Classic upright

For double-sided shelving. Fastened into
the slots of the upright.

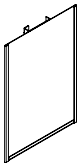

A4 vertical/upright format
A3 vertical/upright format
A4 horizontal format

Item no.

B40110337
B40110338
B40110339

Laminated top sign for 60/30 Classic shelving bays

H150 x W870 mm (H290 mm when
mounted). Only for module 90 cm. To
be mounted in upper crossbar. Ideal
for 60/30 Expo. Laminat available in
white, black and grey.

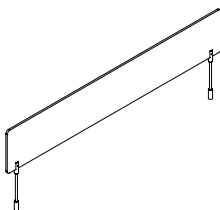

Item no.

B3085039

ACCESSORIES

SIGNAGE - FOR SHELF

Steel sign for wooden top shelf and London wooden overlaying top plate

H4,5 cm. White label to be ordered separately.

Module
cm

Item no.



75	Sign
90	Sign
100	Sign
100	Label

B4010087
B4010087
B4010087
B40113002

Magnetic shelf label - for steel top shelf with 47 mm frontedge

H40 mm. Black. Attach to steel shelves with smooth edge.

Width
mm

Item no.

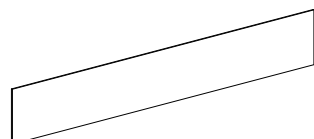

300

B4000020300

Plastic clip-on label holder - for steel shelf S1 with 25 mm frontedge

H25 mm. Incl. white label. Can glide along shelf.

Width
mm

Item no.

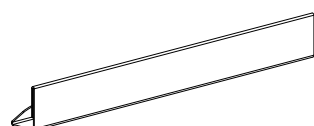

220

B401135

Plastic clip-on label holder - for steel shelf S2 with 25 mm frontedge

H25 mm. Incl. white label. Can glide along shelf.

Width
mm

Item no.

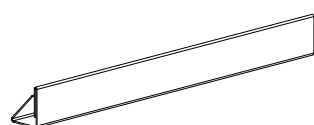

213

E3881

ACCESSORIES

SIGNAGE - FOR SHELF

Self-adhesive plastic label holder - for steel shelf S1/S2 with 25 mm frontedge

H20 mm. Transparent, antireflective plastic. Incl. white label.

Width
mm

Item no.

147
200

B4017124
B4017125

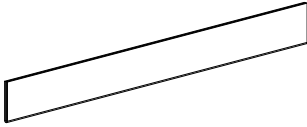

Magnetic plastic label holder - for steel shelf S1/S2 with 25 mm frontedge

H20 mm. Transparent, antireflective plastic. Incl. white label. Attach to steel shelves with smooth edge.

Width
mm

Item no.

210 Self-adhesive plastic label holder
209 White sheet w. 13 labels (spare part)

B4017147
B4017116

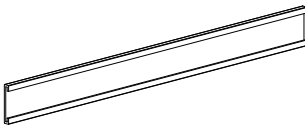

Steel label holder

H26 x W150 x D150 mm. Lacquered steel with transparent, antireflective plastic. Incl. white label. Universal use, simply place on shelf where needed.

Item no.

B401801

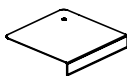

Labelling cube

H200 x D200 mm. Acrylic glass. Inscription field with transparent cover on sloping front. Incl. white cardboard label. Universal use, place in between books on shelf where needed.

Width
mm

Item no.

120
200

B40552011
B40552031

120
200

B4055211
B4055213

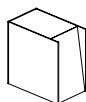

UPRIGHTS

60/30 CLASSIC UPRIGHTS

60/30 uprights - height 92 cm

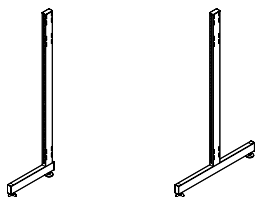

Shelf depth cm	Item no. Single-sided	Item no. Double-sided
22.5	B301000711	B301000712
25	B301000721	B301000722
30	B301000731	B301000732
40	B301000741	B301000742

60/30 Classic uprights - height 122 cm

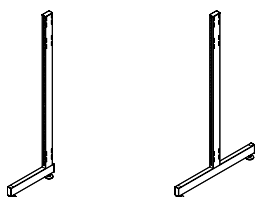

Shelf depth cm	Item no. Single-sided	Item no. Double-sided
22.5	B301000211	B301000212
25	B301000221	B301000222
30	B301000231	B301000232
40	B301000241	B301000242

60/30 Classic uprights - height 152 cm

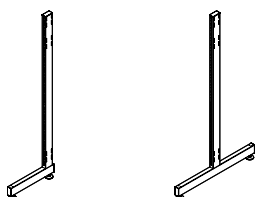

Shelf depth cm	Item no. Single-sided	Item no. Double-sided
22.5	B301000511	B301000512
25	B301000521	B301000522
30	B301000531	B301000532
40	B301000541	B301000542

60/30 Classic uprights - height 182 cm

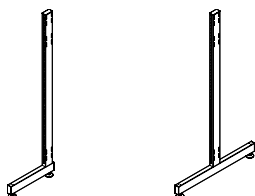

Shelf depth cm	Item no. Single-sided	Item no. Double-sided
22.5	B301000811	B301000812
25	B301000821	B301000822
30	B301000831	B301000832
40	B301000841	B301000842

60/30 Classic uprights - height 199.5 cm

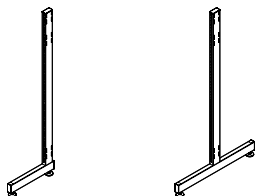

Shelf depth cm	Item no. Single-sided	Item no. Double-sided
22.5	B301000911	B301000912
25	B301000921	B301000922
30	B301000931	B301000932
40	B301000941	B301000942

60/30 Classic uprights - height 212 cm

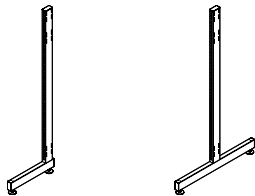

Shelf depth cm	Item no. Single-sided	Item no. Double-sided
22.5	B301000111	B301000112
25	B301000121	B301000122
30	B301000131	B301000132
40	B301000141	B301000142

UPRIGHTS

80/30 CLASSIC UPRIGHTS

80/30 Classic uprights - height 199 cm

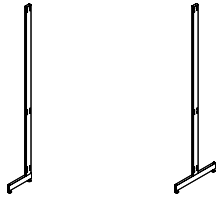

Shelf depth cm	Item no. Single-sided	Item no. Double-sided
22.5	B301060311	B301060312
25	B301060321	B301060322
30	B301060331	B301060332
40	B301060341	B301060342

80/30 Classic uprights - height 229 cm

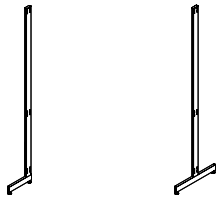

Shelf depth cm	Item no. Single-sided	Item no. Double-sided
22.5	B301060211	B301060212
25	B301060221	B301060222
30	B301060231	B301060232
40	B301060241	B301060242

80/30 Classic uprights - height 259 cm

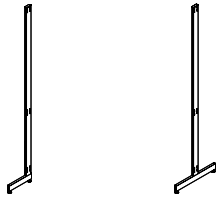

Shelf depth cm	Item no. Single-sided	Item no. Double-sided
22.5	B301060111	B301060112
25	B301060121	B301060122
30	B301060131	B301060132
40	B301060141	B301060142

UPRIGHTS

60/30 CLASSIC WALL STRIPS

60/30 Classic wall strips



Height
cm

112.5
142.5
172.5
202.5

Item no.

B30105011
B30105014
B30105017
B30105020

UPRIGHTS

COMPONENTS FOR HIDDEN CASTOR ASSEMBLY ON 60/30 CLASSIC DOUBLE-SIDED SHELVING

60/30 Classic double-sided upright - height 92 cm

Only to be used with the wheel frame and castor set below. Adjustment of levelling glide makes the shelving non-moveable.

Shelf depth
cm

22.5
25
30
40

Item no.

B30101671
B30101672
B30101673
B30101674



60/30 Classic double-sided upright - height 122 cm

Only to be used with the wheel frame and castor set below. Adjustment of levelling glide makes the shelving non-moveable.

Shelf depth
cm

22.5
25
30
40

Item no.

B30101621
B30101622
B30101623
B30101624



60/30 Classic double-sided upright - height 152 cm

Only to be used with the wheel frame and castor set below. Adjustment of levelling glide makes the shelving non-moveable.

Shelf depth
cm

22.5
25
30
40

Item no.

B30101651
B30101652
B30101653
B30101654



Castor frame and castor set for 60/30 Classic double-sided upright

Fittings included. To hide castors, use plinth for 60/30 shelving, see page 139.

Module
cm

75
90
100

Item no.

B3010187
B3010189
B3010181



COMPONENTS

UPRIGHT EXTENSIONS, CROSSBARS & ANTI-TOPPLE BRACKETS

Upright extension

H30 x D6/D8 x W3 cm.

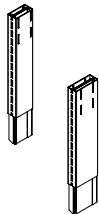

	Item no. 60/30	Item no. 80/30
Single-sided	B3011103061	B3011103081
Double-sided	B3011103062	B3011103082

Crossbar

See technical specifications for amount of crossbars per unit.

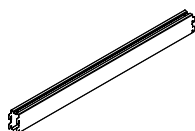

Module cm	Item no.
75	B3010127
90	B3010129
100	B3010121

Anti-topple bracket

Secures single-sided bays to wall.

Item no.

B115507

COMPONENTS

PLINTHS & CASTORS

Steel plinth for 60/30 Classic

H6 x top D3.2 cm. Including screws.

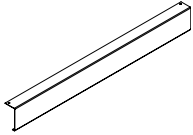

Module cm	Bays	Item no.
75	1	B302015701
75	2	B302015702
75	3	B302015703
90	1	B302015901
90	2	B302015902
100	1	B302015101
100	2	B302015102

Steel plinth for 60/30 Classic - extra depth

H6 x top D13.2 cm. Including screws. To be used when magazine display B3051xx is placed furthest down.

Module cm	Bays	Item no.
75	1	B302025701
75	2	B302025702
75	3	B302025703
90	1	B302025901
90	2	B302025902
100	1	B302025101
100	2	B302025102

Steel plinth for 80/30 Classic

H8 x top D3.2 cm. Including pins.

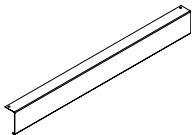

Module cm	Bays	Item no. 80/30
75	1	B3020167
90	1	B3020169
100	1	B3020161

Castors

H9.9 cm.

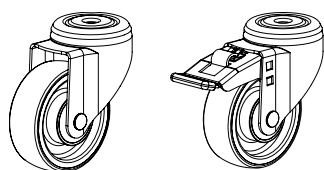

Brakes	Item no.
Without	B3060000
With	B3060001

PANELS

PAINTED WOODEN END PANELS

Painted FSC wooden end panel - single-sided

19 mm front edge. Incl. fittings. These end panels are not compatible with 60/30 Classic wall steel shelving.



Height cm	Shelf depth cm	Item no. Left	Item no. Right
92	22.5	B3016657175	B3016657185
92	25	B3016657275	B3016657285
92	30	B3016657375	B3016657385
92	40	B3016657475	B3016657485
122	22.5	B3016652175	B3016652185
122	25	B3016652275	B3016652285
122	30	B3016652375	B3016652385
122	40	B3016652475	B3016652485
152	22.5	B3016655175	B3016655185
152	25	B3016655275	B3016655285
152	30	B3016655375	B3016655385
152	40	B3016655475	B3016655485
182	22.5	B3016658175	B3016658185
182	25	B3016658275	B3016658285
182	30	B3016658375	B3016658385
182	40	B3016658475	B3016658485
199.5	22.5	B3016659175	B3016659185
199.5	25	B3016659275	B3016659285
199.5	30	B3016659375	B3016659385
199.5	40	B3016659475	B3016659485
212	22.5	B3016651175	B3016651185
212	25	B3016651275	B3016651285
212	30	B3016651375	B3016651385
212	40	B3016651475	B3016651485

Painted FSC wooden end panel - double-sided

19 mm front edge. Incl. fittings. These end panels are not compatible with hidden castor frames.

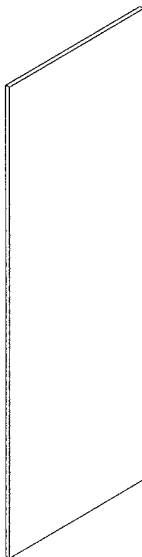

Height cm	Shelf depth cm	Item no.
92	22.5	B3016657195
92	25	B3016657295
92	30	B3016657395
92	40	B3016657495
122	22.5	B3016652195
122	25	B3016652295
122	30	B3016652395
122	40	B3016652495
152	22.5	B3016655195
152	25	B3016655295
152	30	B3016655395
152	40	B3016655495
182	22.5	B3016658195
182	25	B3016658295
182	30	B3016658395
182	40	B3016658495
199.5	22.5	B3016659195
199.5	25	B3016659295
199.5	30	B3016659395
199.5	40	B3016659495
212	22.5	B3016651195
212	25	B3016651295
212	30	B3016651395
212	40	B3016651495

Veneer FSC wooden end panel - single-sided

19 mm front edge. Incl. fittings. These end panels are not compatible with 60/30 Classic wall steel shelving.



Height cm	Shelf depth cm	Item no. Left	Item no. Right
92	22.5	B3016657171	B3016657181
92	25	B3016657271	B3016657281
92	30	B3016657371	B3016657381
92	40	B3016657471	B3016657481
122	22.5	B3016652171	B3016652181
122	25	B3016652271	B3016652281
122	30	B3016652371	B3016652381
122	40	B3016652471	B3016652481
152	22.5	B3016655171	B3016655181
152	25	B3016655271	B3016655281
152	30	B3016655371	B3016655381
152	40	B3016655471	B3016655481
182	22.5	B3016658171	B3016658181
182	25	B3016658271	B3016658281
182	30	B3016658371	B3016658381
182	40	B3016658471	B3016658481
199.5	22.5	B3016659171	B3016659181
199.5	25	B3016659271	B3016659281
199.5	30	B3016659371	B3016659381
199.5	40	B3016659471	B3016659481
212	22.5	B3016651171	B3016651181
212	25	B3016651271	B3016651281
212	30	B3016651371	B3016651381
212	40	B3016651471	B3016651481

Veneer FSC wooden end panel - double-sided

19 mm front edge. Incl. fittings. These end panels are not compatible with hidden castor frames.

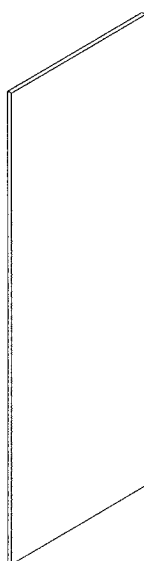

Height cm	Shelf depth cm	Item no.
92	22.5	B3016657191
92	25	B3016657291
92	30	B3016657391
92	40	B3016657491
122	22.5	B3016652191
122	25	B3016652291
122	30	B3016652391
122	40	B3016652491
152	22.5	B3016655191
152	25	B3016655291
152	30	B3016655391
152	40	B3016655491
182	22.5	B3016658191
182	25	B3016658291
182	30	B3016658391
182	40	B3016658491
199.5	22.5	B3016659191
199.5	25	B3016659291
199.5	30	B3016659391
199.5	40	B3016659491
212	22.5	B3016651191
212	25	B3016651291
212	30	B3016651391
212	40	B3016651491

PANELS

PAINTED WOODEN SLAT END PANELS

Painted FSC wooden slat end panel - single-sided

22 mm front edge. Incl. fittings. These end panels are not compatible with 60/30 Classic wall steel shelving.

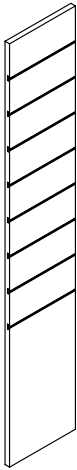

Height cm	Shelf depth cm	Item no. Left	Item no. Right
92	22.5	B3016747175	B3016747185
92	25	B3016747275	B3016747285
92	30	B3016747375	B3016747385
92	40	B3016747475	B3016747485
122	22.5	B3016742175	B3016742185
122	25	B3016742275	B3016742285
122	30	B3016742375	B3016742385
122	40	B3016742475	B3016742485
152	22.5	B3016745175	B3016745185
152	25	B3016745275	B3016745285
152	30	B3016745375	B3016745385
152	40	B3016745475	B3016745485
182	22.5	B3016748175	B3016748185
182	25	B3016748275	B3016748285
182	30	B3016748375	B3016748385
182	40	B3016748475	B3016748485
212	22.5	B3016741175	B3016741185
212	25	B3016741275	B3016741285
212	30	B3016741375	B3016741385
212	40	B3016741475	B3016741485

Painted FSC wooden slat end panel - double-sided

22 mm front edge. Incl. fittings. These end panels are not compatible with hidden castor frames.

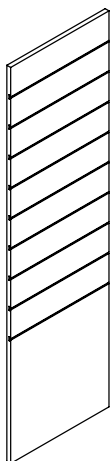

Height cm	Shelf depth cm	Item no.
92	22.5	B3016747195
92	25	B3016747295
92	30	B3016747395
92	40	B3016747495
122	22.5	B3016742195
122	25	B3016742295
122	30	B3016742395
122	40	B3016742495
152	22.5	B3016745195
152	25	B3016745295
152	30	B3016745395
152	40	B3016745495
182	22.5	B3016748195
182	25	B3016748295
182	30	B3016748395
182	40	B3016748495
212	22.5	B3016741195
212	25	B3016741295
212	30	B3016741395
212	40	B3016741495

Veneer FSC wooden slat end panel - single-sided

22 mm front edge. Incl. fittings. These end panels are not compatible with 60/30 Classic wall steel shelving.

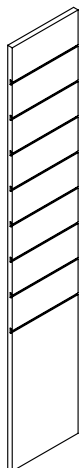

Height cm	Shelf depth cm	Item no. Left	Item no. Right
92	22.5	B3016747171	B3016747181
92	25	B3016747271	B3016747281
92	30	B3016747371	B3016747381
92	40	B3016747471	B3016747481
122	22.5	B3016742171	B3016742181
122	25	B3016742271	B3016742281
122	30	B3016742371	B3016742381
122	40	B3016742471	B3016742481
152	22.5	B3016745171	B3016745181
152	25	B3016745271	B3016745281
152	30	B3016745371	B3016745381
152	40	B3016745471	B3016745481
182	22.5	B3016748171	B3016748181
182	25	B3016748271	B3016748281
182	30	B3016748371	B3016748381
182	40	B3016748471	B3016748481
212	22.5	B3016741171	B3016741181
212	25	B3016741271	B3016741281
212	30	B3016741371	B3016741381
212	40	B3016741471	B3016741481

Veneer FSC wooden slat end panel - double-sided

22 mm front edge. Incl. fittings. These end panels are not compatible with hidden castor frames.



Height cm	Shelf depth cm	Item no.
92	22.5	B3016747191
92	25	B3016747291
92	30	B3016747391
92	40	B3016747491
122	22.5	B3016742191
122	25	B3016742291
122	30	B3016742391
122	40	B3016742491
152	22.5	B3016745191
152	25	B3016745291
152	30	B3016745391
152	40	B3016745491
182	22.5	B3016748191
182	25	B3016748291
182	30	B3016748391
182	40	B3016748491
212	22.5	B3016741191
212	25	B3016741291
212	30	B3016741391
212	40	B3016741491

PANELS

PAINTED LONDON WOODEN END PANELS - FOR STEEL TOP SHELF

Painted FSC London wooden end panel for steel top shelf - single-sided

30 mm front edge. To be used with steel top shelf, see pages 76-95. Incl. fittings. These end panels are not compatible with 60/30 Classic Classic wall steel shelving.

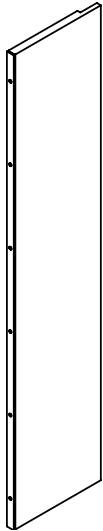

Height cm	Shelf depth cm	Item no. Left	Item no. Right
92	22.5	B3021257172	B3021257182
92	25	B3021257272	B3021257282
92	30	B3021257372	B3021257382
92	40	B3021257472	B3021257482
122	22.5	B3021252172	B3021252182
122	25	B3021252272	B3021252282
122	30	B3021252372	B3021252382
122	40	B3021252472	B3021252482
152	22.5	B3021255172	B3021255182
152	25	B3021255272	B3021255282
152	30	B3021255372	B3021255382
152	40	B3021255472	B3021255482
182	22.5	B3021258172	B3021258182
182	25	B3021258272	B3021258282
182	30	B3021258372	B3021258382
182	40	B3021258472	B3021258482
212	22.5	B3021251172	B3021251182
212	25	B3021251272	B3021251282
212	30	B3021251372	B3021251382
212	40	B3021251472	B3021251482

Painted FSC London wooden end panel for steel top shelf - double-sided

30 mm front edge. To be used with steel top shelf, see pages 76-95. Incl. fittings.

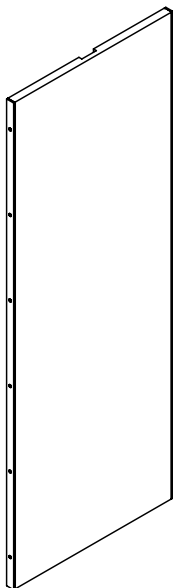

Height cm	Shelf depth cm	Item no.
92	22.5	B3021257192
92	25	B3021257292
92	30	B3021257392
92	40	B3021257492
122	22.5	B3021252192
122	25	B3021252292
122	30	B3021252392
122	40	B3021252492
152	22.5	B3021255192
152	25	B3021255292
152	30	B3021255392
152	40	B3021255492
182	22.5	B3021258192
182	25	B3021258292
182	30	B3021258392
182	40	B3021258492
212	22.5	B3021251192
212	25	B3021251292
212	30	B3021251392
212	40	B3021251492

PAINTED LONDON WOODEN END PANELS - FOR LONDON OVERLAYING TOP PLATE

Painted FSC London wooden end panel for wooden overlaying top plate - single-sided

30 mm front edge. To be used with London wooden overlaying top, see pages 106-111. Incl. fittings. These end panels are not compatible with 60/30 Classic wall steel shelving.

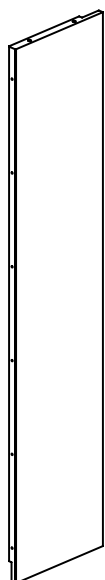

Height cm	Shelf depth cm	Item no. Left	Item no. Right
92	22.5	B3021257171	B3021257181
92	25	B3021257271	B3021257281
92	30	B3021257371	B3021257381
92	40	B3021257471	B3021257481
122	22.5	B3021252171	B3021252181
122	25	B3021252271	B3021252281
122	30	B3021252371	B3021252381
122	40	B3021252471	B3021252481
152	22.5	B3021255171	B3021255181
152	25	B3021255271	B3021255281
152	30	B3021255371	B3021255381
152	40	B3021255471	B3021255481
182	22.5	B3021258171	B3021258181
182	25	B3021258271	B3021258281
182	30	B3021258371	B3021258381
182	40	B3021258471	B3021258481
212	22.5	B3021251171	B3021251181
212	25	B3021251271	B3021251281
212	30	B3021251371	B3021251381
212	40	B3021251471	B3021251481

Painted FSC London wooden end panel for wooden overlaying top plate - double-sided

30 mm front edge. To be used with London wooden overlaying top, see pages 106-111. Incl. fittings.

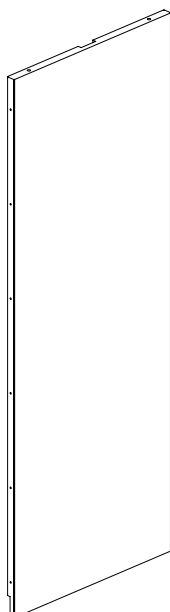

Height cm	Shelf depth cm	Item no.
92	22.5	B3021257191
92	25	B3021257291
92	30	B3021257391
92	40	B3021257491
122	22.5	B3021252191
122	25	B3021252291
122	30	B3021252391
122	40	B3021252491
152	22.5	B3021255191
152	25	B3021255291
152	30	B3021255391
152	40	B3021255491
182	22.5	B3021258191
182	25	B3021258291
182	30	B3021258391
182	40	B3021258491
212	22.5	B3021251191
212	25	B3021251291
212	30	B3021251391
212	40	B3021251491

PANELS

PERFORATED STEEL END PANEL

Perforated steel end panels - single-sided

45 mm frontedge. One A5 acrylic cover for signage and fittings are included. Hole size Ø4,5 mm. These end panels are not compatible with 60/30 Classic wall steel shelving.

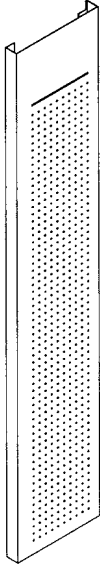

Height cm	Shelf depth cm	Item no. Left	Item no. Right
92	22.5	B301600717	B301600718
92	25	B301600727	B301600728
92	30	B301600737	B301600738
92	40	B301600747	B301600748
122	22.5	B301600217	B301600218
122	25	B301600227	B301600228
122	30	B301600237	B301600238
122	40	B301600247	B301600248
152	22.5	B301600517	B301600518
152	25	B301600527	B301600528
152	30	B301600537	B301600538
152	40	B301600547	B301600548
182	22.5	B301600817	B301600818
182	25	B301600827	B301600828
182	30	B301600837	B301600838
182	40	B301600847	B301600848
199.5	22.5	B301600917	B301600918
199.5	25	B301600927	B301600928
199.5	30	B301600937	B301600938
199.5	40	B301600947	B301600948
212	22.5	B301600117	B301600118
212	25	B301600127	B301600128
212	30	B301600137	B301600138
212	40	B301600147	B301600148

Perforated steel end panels - double-sided

45 mm frontedge. Two A5 acrylic covers for signage and fittings are included. Hole size Ø4,5 mm

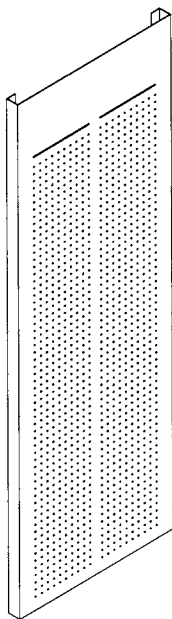

Height cm	Shelf depth cm	Item no.
92	22.5	B301600719
92	25	B301600729
92	30	B301600739
92	40	B301600749
122	22.5	B301600219
122	25	B301600229
122	30	B301600239
122	40	B301600249
152	22.5	B301600519
152	25	B301600529
152	30	B301600539
152	40	B301600549
182	22.5	B301600819
182	25	B301600829
182	30	B301600839
182	40	B301600849
199.5	22.5	B301600919
199.5	25	B301600929
199.5	30	B301600939
199.5	40	B301600949
212	22.5	B301600119
212	25	B301600129
212	30	B301600139
212	40	B301600149

LONDON STEEL END PANELS - FOR LONDON STEEL OVERLAYING TOP PLATE

London steel end panel for London steel overlaying top plate - single-sided

30 mm front edge. To be used with London steel overlaying top plate, see page 98-99. Incl. fittings. These end panels are not compatible with 60/30 Classic wall steel shelving.

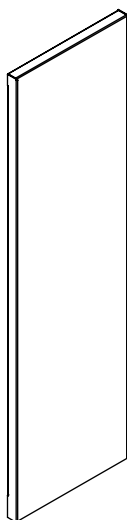

Height cm	Shelf depth cm	Item no. Left	Item no. Right
92	22.5	B30162071730	B30162071830
92	25	B30162072730	B30162072830
92	30	B30162073730	B30162073830
92	40	B30162074730	B30162074830
122	22.5	B30162012730	B30162021830
122	25	B30162022730	B30162022830
122	30	B30162023730	B30162023830
122	40	B30162024730	B30162024830
152	22.5	B30162051730	B30162051830
152	25	B30162052730	B30162052830
152	30	B30162053730	B30162053830
152	40	B30162054730	B30162054830
182	22.5	B30162081730	B30162081830
182	25	B30162082730	B30162082830
182	30	B30162083730	B30162083830
182	40	B30162084730	B30162084830
212	22.5	B30162011730	B30162011830
212	25	B30162012730	B30162012830
212	30	B30162013730	B30162013830
212	40	B30162014730	B30162014830

London steel end panel for London steel overlaying top plate - double-sided

30 mm front edge. To be used with London steel overlaying top plate, see page 100-101. Incl. fittings.

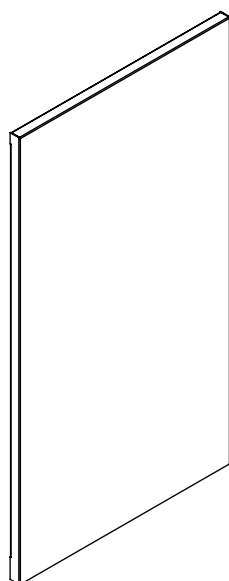

Height cm	Shelf depth cm	Item no.
92	22.5	B30162071930
92	25	B30162072930
92	30	B30162073930
92	40	B30162074930
122	22.5	B30162021930
122	25	B30162022930
122	30	B30162023930
122	40	B30162024930
152	22.5	B30162051930
152	25	B30162052930
152	30	B30162053930
152	40	B30162054930
182	22.5	B30162081930
182	25	B30162082930
182	30	B30162083930
182	40	B30162084930
212	22.5	B30162011930
212	25	B30162012930
212	30	B30162013930
212	40	B30162014930

PANELS

GLASS END PANELS

Glass end panel - single-sided

10 mm front edge. Incl. fittings. These end panels are not compatible with 60/30 Classic wall steel shelving.



Height cm	Shelf depth cm	Item no. Left	Item no. Right
92	22.5	B301647771	B301647871
92	25	B301647772	B301647872
92	30	B301647773	B301647873
92	40	B301647774	B301647874
122	22.5	B301647721	B301647821
122	25	B301647722	B301647822
122	30	B301647723	B301647823
122	40	B301647724	B301647824
152	22.5	B301647751	B301647851
152	25	B301647752	B301647852
152	30	B301647753	B301647853
152	40	B301647754	B301647854
182	22.5	B301647781	B301647881
182	25	B301647782	B301647882
182	30	B301647783	B301647883
182	40	B301647784	B301647884
199.5	22.5	B301647791	B301647891
199.5	25	B301647792	B301647892
199.5	30	B301647793	B301647893
199.5	40	B301647794	B301647894
212	22.5	B301647711	B301647811
212	25	B301647712	B301647812
212	30	B301647713	B301647813
212	40	B301647714	B301647814

Glass end panel - double-sided

10 mm front edge. Incl. fittings.

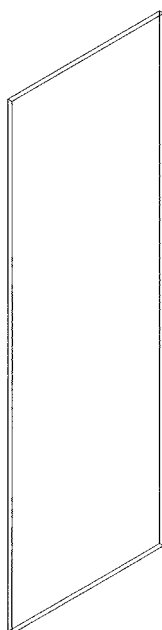

Height cm	Shelf depth cm	Item no.
92	22.5	B301647971
92	25	B301647972
92	30	B301647973
92	40	B301647974
122	22.5	B301647921
122	25	B301647922
122	30	B301647923
122	40	B301647924
152	22.5	B301647951
152	25	B301647952
152	30	B301647953
152	40	B301647954
182	22.5	B301647981
182	25	B301647982
182	30	B301647983
182	40	B301647984
199.5	22.5	B301647991
199.5	25	B301647992
199.5	30	B301647993
199.5	40	B301647994
212	22.5	B301647911
212	25	B301647912
212	30	B301647913
212	40	B301647914

PANELS

WOODEN BACK PANELS

FSC wooden back panel

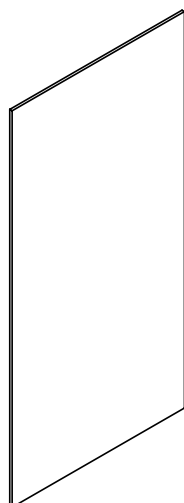

Height cm	Module cm	Item no. Painted	Item no. Veneer
92	75	B301902775	B301902771
92	90	B301902795	B301902791
92	100	B301902715	B301902711
122	75	B301902275	B301902271
122	90	B301902295	B301902291
122	100	B301902215	B301902211
152	75	B301902575	B301902571
152	90	B301902595	B301902591
152	100	B301902515	B301902511
182	75	B301902875	B301902871
182	90	B301902895	B301902891
182	100	B301902815	B301902811
199.5	75	B301902975	B301902971
199.5	90	B301902995	B301902991
199.5	100	B301902915	B301902911
212	75	B301902175	B301902171
212	90	B301902195	B301902191
212	100	B301902115	B301902111

Fittings for wooden end panel

Type	Item no. Heights < 152 cm	Item no. Heights > =152 cm
Left	B30165227	B30165217
Right	B30165228	B30165218
Double	B30165229	B30165219

Fittings for wooden display end panel

Type	Item no. Heights < 152 cm	Item no. Heights > =152 cm
Left	B30167227	B30167217
Right	B30167228	B30167218
Double	B30167229	B30167219

Fittings for glass end panel

Type	Item no.
Left	B3016487
Right	B3016488
Double	B3016489



END PANEL BAYS

FOR DOUBLE-SIDED 60/30 CLASSIC STEEL SHELVING

The following pages will show basic configurations of end panel bays for double-sided 60/30 Classic Steel Shelving system.



END PANEL BAYS

FOR DOUBLE-SIDED SHELVING WITH ADJUSTABLE FEET

FSC-approved end panel bay with wooden top shelf, wooden panels, wooden bottom shelf and adjustable feet. For shelves, see page 158.

Height 92 cm

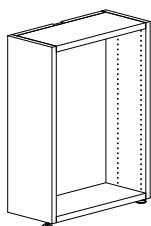

Depth of shelving system - cm	Width of end panel bay - cm	Depth of end panel bay - cm	Item no. Painted	Item no. Veneer
22,5/22,5	46,8	25	BB30130706005	BB30130706001
25/25	51,8	25	BB30130714005	BB30130714001
30/30	61,8	25	BB30130722005	BB30130722001
40/40	81,8	25	BB30130730005	BB30130730001
22,5/22,5	46,8	30	BB30130707005	BB30130707001
25/25	51,8	30	BB30130715005	BB30130715001
30/30	61,8	30	BB30130723005	BB30130723001
40/40	81,8	30	BB30130731005	BB30130731001

Height 122

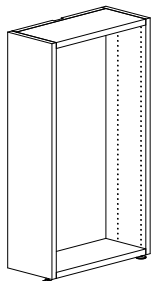

Depth of shelving system - cm	Width of end panel bay - cm	Depth of end panel bay - cm	Item no. Painted	Item no. Veneer
22,5/22,5	46,8	25	BB30130206005	BB30130206001
25/25	51,8	25	BB30130214005	BB30130214001
30/30	61,8	25	BB30130222005	BB30130222001
40/40	81,8	25	BB30130230005	BB30130230001
22,5/22,5	46,8	30	BB30130207005	BB30130207001
25/25	51,8	30	BB30130215005	BB30130215001
30/30	61,8	30	BB30130223005	BB30130223001
40/40	81,8	30	BB30130231005	BB30130231001

Height 152 cm

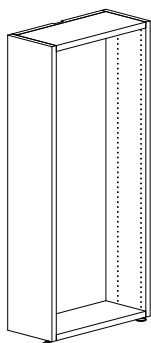

Depth of shelving system - cm	Width of end panel bay - cm	Depth of end panel bay - cm	Item no. Painted	Item no. Veneer
22,5/22,5	46,8	25	BB30130506005	BB30130506001
25/25	51,8	25	BB30130514005	BB30130514001
30/30	61,8	25	BB30130522005	BB30130522001
40/40	81,8	25	BB30130530005	BB30130530001
22,5/22,5	46,8	30	BB30130507005	BB30130507001
25/25	51,8	30	BB30130515005	BB30130515001
30/30	61,8	30	BB30130523005	BB30130523001
40/40	81,8	30	BB30130531005	BB30130531001

END PANEL BAYS

FOR DOUBLE-SIDED SHELVING WITH ADJUSTABLE FEET

FSC-approved end panel bay with wooden top shelf, wooden panels, wooden bottom shelf and adjustable feet. For shelves, see page 158.

Height 182 cm

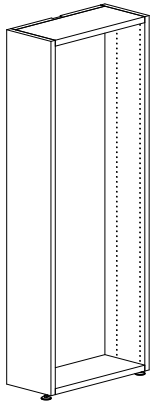

Depth of shelving system - cm	Width of end panel bay - cm	Depth of end panel bay - cm	Item no. Painted	Item no. Veneer
22,5/22,5	46,8	25	BB30130806005	BB30130806001
25/25	51,8	25	BB30130814005	BB30130814001
30/30	61,8	25	BB30130822005	BB30130822001
40/40	81,8	25	BB30130830005	BB30130830001
22,5/22,5	46,8	30	BB30130807005	BB30130807001
25/25	51,8	30	BB30130815005	BB30130815001
30/30	61,8	30	BB30130823005	BB30130823001
40/40	81,8	30	BB30130831005	BB30130831001

Height 212 cm

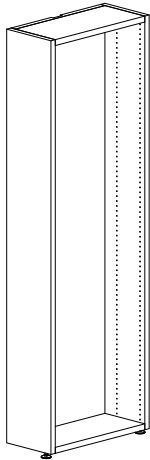

Depth of shelving system - cm	Width of end panel bay - cm	Depth of end panel bay - cm	Item no. Painted	Item no. Veneer
22,5/22,5	46,8	25	BB30130106005	BB30130106001
25/25	51,8	25	BB30130114005	BB30130114001
30/30	61,8	25	BB30130122005	BB30130122001
40/40	81,8	25	BB30130130005	BB30130130001
22,5/22,5	46,8	30	BB30130107005	BB30130107001
25/25	51,8	30	BB30130115005	BB30130115001
30/30	61,8	30	BB30130123005	BB30130123001
40/40	81,8	30	BB30130131005	BB30130131001

END PANEL BAYS

FOR DOUBLE-SIDED SHELVING WITH AJDUSTABLE FEET & LONDON WOODEN TOP PLATE

FSC-approved end panel bay with overlaying London wooden top plate, wooden panels, wooden bottom shelf and adjustable feet. For shelves, see page 158.

Height 92 cm

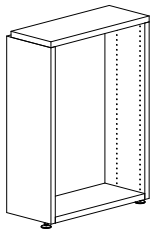

Depth of shelving system - cm	Width of end panel bay - cm	Depth of end panel bay - cm	Item no. Painted	Item no. Veneer
22,5/22,5	46,8	25	BB30131706005	BB30131706001
25/25	51,8	25	BB30131714005	BB30131714001
30/30	61,8	25	BB30131722005	BB30131722001
40/40	81,8	25	BB30131730005	BB30131730001
22,5/22,5	46,8	30	BB30131707005	BB30131707001
25/25	51,8	30	BB30131715005	BB30131715001
30/30	61,8	30	BB30131723005	BB30131723001
40/40	81,8	30	BB30131731005	BB30131731001

Height 122

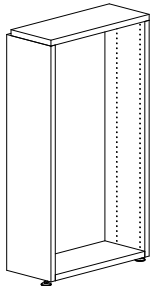

Depth of shelving system - cm	Width of end panel bay - cm	Depth of end panel bay - cm	Item no. Painted	Item no. Veneer
22,5/22,5	46,8	25	BB30131206005	BB30131206001
25/25	51,8	25	BB30131214005	BB30131214001
30/30	61,8	25	BB30131222005	BB30131222001
40/40	81,8	25	BB30131230005	BB30131230001
22,5/22,5	46,8	30	BB30131207005	BB30131207001
25/25	51,8	30	BB30131215005	BB30131215001
30/30	61,8	30	BB30131223005	BB30131223001
40/40	81,8	30	BB30131231005	BB30131231001

Height 152 cm

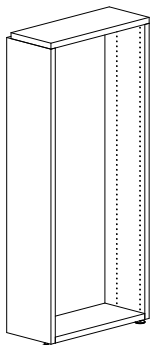

Depth of shelving system - cm	Width of end panel bay - cm	Depth of end panel bay - cm	Item no. Painted	Item no. Veneer
22,5/22,5	46,8	25	BB30131506005	BB30131506001
25/25	51,8	25	BB30131514005	BB30131514001
30/30	61,8	25	BB30131522005	BB30131522001
40/40	81,8	25	BB30131530005	BB30131530001
22,5/22,5	46,8	30	BB30131507005	BB30131507001
25/25	51,8	30	BB30131515005	BB30131515001
30/30	61,8	30	BB30131523005	BB30131523001
40/40	81,8	30	BB30131531005	BB30131531001

END PANEL BAYS

FOR DOUBLE-SIDED SHELVING WITH ADJUSTABLE FEET & LONDON WOODEN TOP PLATE

FSC-approved end panel bay with overlaying London wooden top plate, wooden panels, wooden bottom shelf and adjustable feet. For shelves, see page 158.

Height 182 cm

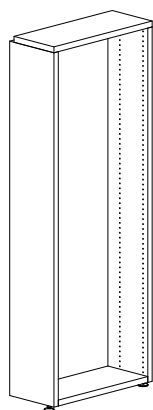

Depth of shelving system - cm	Width of end panel bay - cm	Depth of end panel bay - cm	Item no. Painted	Item no. Veneer
22,5/22,5	46,8	25	BB30131806005	BB30131806001
25/25	51,8	25	BB30131814005	BB30131814001
30/30	61,8	25	BB30131822005	BB30131822001
40/40	81,8	25	BB30131830005	BB30131830001
22,5/22,5	46,8	30	BB30131807005	BB30131807001
25/25	51,8	30	BB30131815005	BB30131815001
30/30	61,8	30	BB30131823005	BB30131823001
40/40	81,8	30	BB30131831005	BB30131831001

Height 212 cm

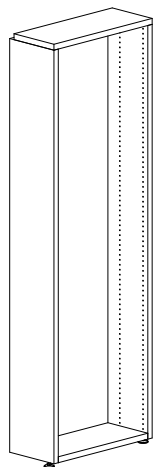

Depth of shelving system - cm	Width of end panel bay - cm	Depth of end panel bay - cm	Item no. Painted	Item no. Veneer
22,5/22,5	46,8	25	BB30131106005	BB30131106001
25/25	51,8	25	BB30131114005	BB30131114001
30/30	61,8	25	BB30131122005	BB30131122001
40/40	81,8	25	BB30131130005	BB30131130001
22,5/22,5	46,8	30	BB30131107005	BB30131107001
25/25	51,8	30	BB30131115005	BB30131115001
30/30	61,8	30	BB30131123005	BB30131123001
40/40	81,8	30	BB30131131005	BB30131131001

END PANEL BAYS

FOR DOUBLE-SIDED SHELVING WITH CASTORS

FSC-approved end panel bay with wooden top shelf, wooden panels, wooden bottom shelf and castors. For shelves, see page 158.

Height 92 cm

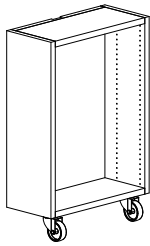

Depth of shelving system - cm	Width of end panel bay - cm	Depth of end panel bay - cm	Item no. Painted	Item no. Veneer
22,5/22,5	46,8	25	BB30134706005	BB30134706001
25/25	51,8	25	BB30134714005	BB30134714001
30/30	61,8	25	BB30134722005	BB30134722001
40/40	81,8	25	BB30134730005	BB30134730001
22,5/22,5	46,8	30	BB30134707005	BB30134707001
25/25	51,8	30	BB30134715005	BB30134715001
30/30	61,8	30	BB30134723005	BB30134723001
40/40	81,8	30	BB30134731005	BB30134731001

Height 122

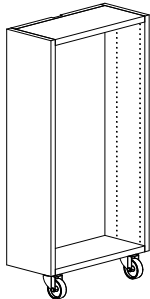

Depth of shelving system - cm	Width of end panel bay - cm	Depth of end panel bay - cm	Item no. Painted	Item no. Veneer
22,5/22,5	46,8	25	BB30134206005	BB30134206001
25/25	51,8	25	BB30134214005	BB30134214001
30/30	61,8	25	BB30134222005	BB30134222001
40/40	81,8	25	BB30134230005	BB30134230001
22,5/22,5	46,8	30	BB30134207005	BB30134207001
25/25	51,8	30	BB30134215005	BB30134215001
30/30	61,8	30	BB30134223005	BB30134223001
40/40	81,8	30	BB30134231005	BB30134231001

Height 152 cm

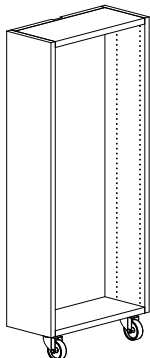

Depth of shelving system - cm	Width of end panel bay - cm	Depth of end panel bay - cm	Item no. Painted	Item no. Veneer
22,5/22,5	46,8	25	BB30134506005	BB30134506001
25/25	51,8	25	BB30134514005	BB30134514001
30/30	61,8	25	BB30134522005	BB30134522001
40/40	81,8	25	BB30134530005	BB30134530001
22,5/22,5	46,8	30	BB30134507005	BB30134507001
25/25	51,8	30	BB30134515005	BB30134515001
30/30	61,8	30	BB30134523005	BB30134523001
40/40	81,8	30	BB30134531005	BB30134531001

END PANEL BAYS

FOR DOUBLE-SIDED SHELVING WITH CASTORS & LONDON WOODEN TOP PLATE

FSC-approved end panel bay with overlaying London wooden top plate, wooden panels, wooden bottom shelf and castors. For shelves, see page 158.

Height 92 cm

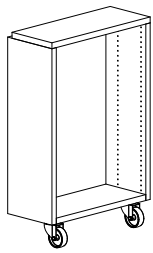

Depth of shelving system - cm	Width of end panel bay - cm	Depth of end panel bay - cm	Item no. Painted	Item no. Veneer
22,5/22,5	46,8	25	BB30135706005	BB30135706001
25/25	51,8	25	BB30135714005	BB30135714001
30/30	61,8	25	BB30135722005	BB30135722001
40/40	81,8	25	BB30135730005	BB30135730001
22,5/22,5	46,8	30	BB30135707005	BB30135707001
25/25	51,8	30	BB30135715005	BB30135715001
30/30	61,8	30	BB30135723005	BB30135723001
40/40	81,8	30	BB30135731005	BB30135731001

Height 122

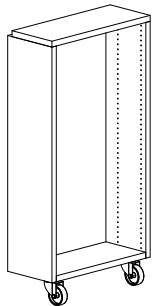

Depth of shelving system - cm	Width of end panel bay - cm	Depth of end panel bay - cm	Item no. Painted	Item no. Veneer
22,5/22,5	46,8	25	BB30135206005	BB30135206001
25/25	51,8	25	BB30135214005	BB30135214001
30/30	61,8	25	BB30135222005	BB30135222001
40/40	81,8	25	BB30135230005	BB30135230001
22,5/22,5	46,8	30	BB30135207005	BB30135207001
25/25	51,8	30	BB30135215005	BB30135215001
30/30	61,8	30	BB30135223005	BB30135223001
40/40	81,8	30	BB30135231005	BB30135231001

Height 152 cm

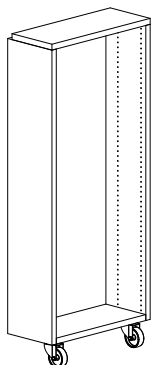

Depth of shelving system - cm	Width of end panel bay - cm	Depth of end panel bay - cm	Item no. Painted	Item no. Veneer
22,5/22,5	46,8	25	BB30135506005	BB30135506001
25/25	51,8	25	BB30135514005	BB30135514001
30/30	61,8	25	BB30135522005	BB30135522001
40/40	81,8	25	BB30135530005	BB30135530001
22,5/22,5	46,8	30	BB30135507005	BB30135507001
25/25	51,8	30	BB30135515005	BB30135515001
30/30	61,8	30	BB30135523005	BB30135523001
40/40	81,8	30	BB30135531005	BB30135531001

END PANEL BAYS

STEEL SHELVES

Steel shelf with steel backedge for backedge book support

Steel backedge 47 mm.
Brackets must be ordered
separately.

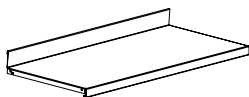

Depth of shelving system - cm	Depth of end panel bay - cm	Width of shelf - cm	Item no.
22,5/22,5	25	46,3	B30118206
25/25	25	51,3	B30118214
30/30	25	61,3	B30118222
40/40	25	71,3	B30118230
22,5/22,5	30	46,3	B30118207
25/25	30	51,3	B30118215
30/30	30	61,3	B30118223
40/40	30	71,3	B30118231

Bracket for steel shelves with steel backedge

* Can be used for D25 and
30 cm shelves.

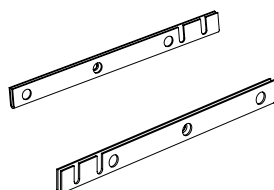

Type	Depth of end panel bay - cm	Item no.
Left	25	B78300128
Right	25	B78300129
Left*	30	B78300138
Right*	30	B78300139

45°/60° sloping steel shelf

With fittings.



Depth of shelving system - cm	Depth of end panel bay - cm	Item no.
22,5/22,5	25	B30118606
25/25	25	B30118614
30/30	25	B30118622
40/40	25	B30118630
22,5/22,5	30	B30118607
25/25	30	B30118615
30/30	30	B30118623
40/40	30	B30118631



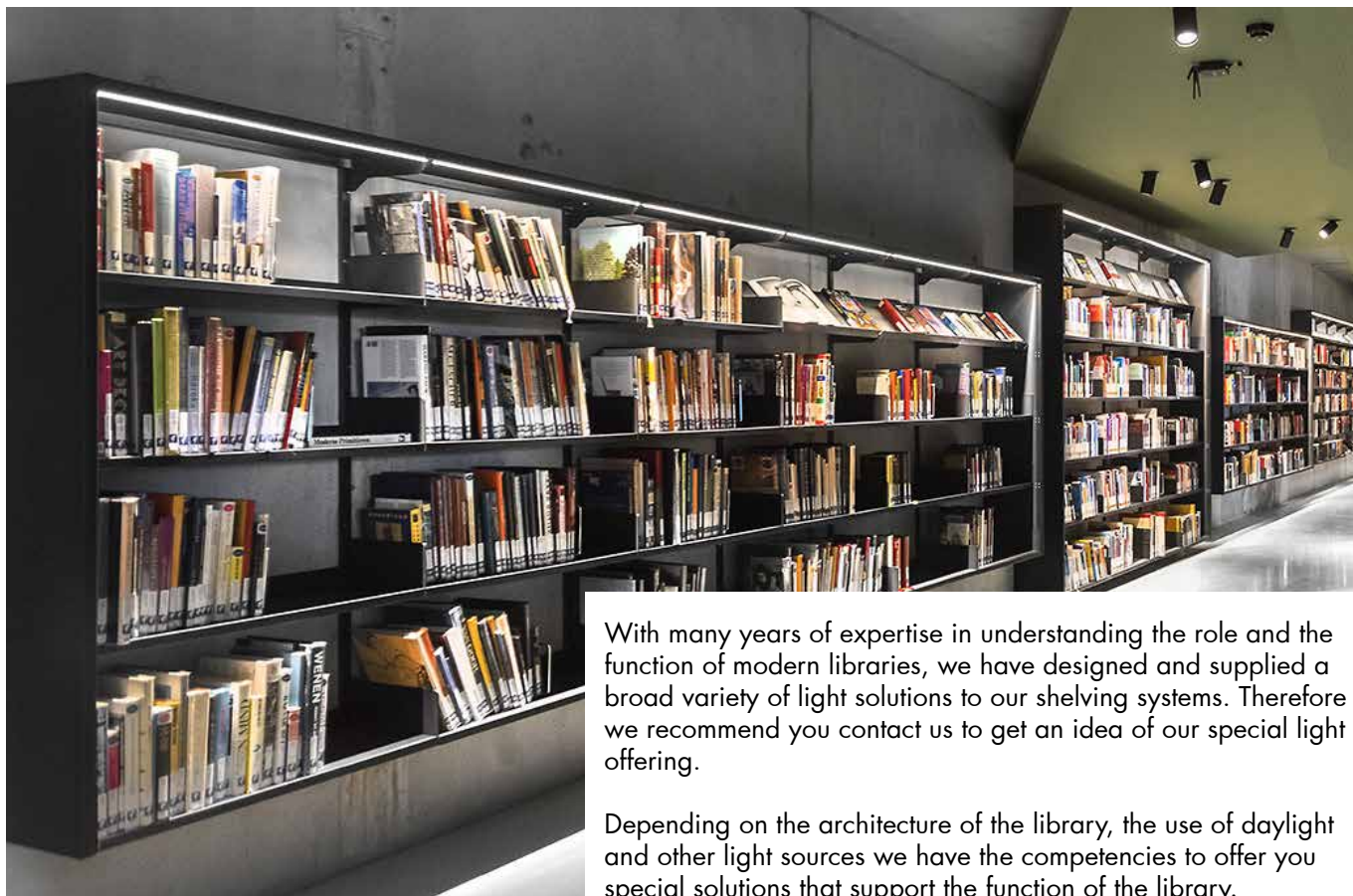

With many years of expertise in understanding the role and the function of modern libraries, we have designed and supplied a broad variety of light solutions to our shelving systems. Therefore we recommend you contact us to get an idea of our special light offering.

Depending on the architecture of the library, the use of daylight and other light sources we have the competencies to offer you special solutions that support the function of the library.

The LED lighting strips are mounted underneath each steel shelf to add light to the shelf below. You can find complete shelving configurations on page 40. Below you will find an overview of all components used in a configuration with LED lighting. It is also possible to construct your own shelving using the standard and special constructed components for LED lighting, contact Sales for further details.

Warm white LED lighting

Selfadhesive. 3000 kelvin. 12V. 4.8 W per meter. Energy efficiency A+. 60 diodes per meter. Light output (lm) 4.1 per meter.

Module cm
75
90
100

Item no.
B3900208
B3900205
B3900200

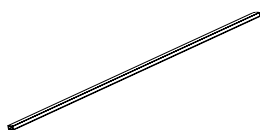

12V DC transformer for LED lighting

Up to 6 connections. 30 W. IP20.

Item no.
B3900202

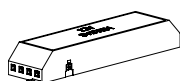

Transformer holder for LED lighting

1 pc. needed per bay.



Module cm
75
90
100

Item no.
B3030037
B3030039
B3030031

Cable channel for LED lighting

To be mounted on the left hand side of the bay, on the inside of the upright.

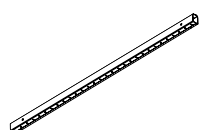

Height cm
122
152
182
212

Item no.
B3030042
B3030045
B3030048
B3030041

Upright for LED lighting

With extra holes for mounting cable channel.

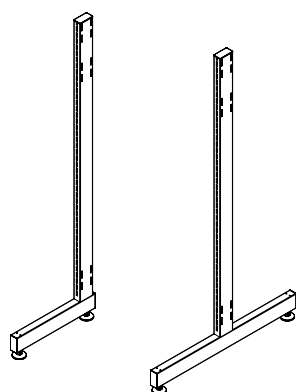

Height cm	Depth cm	Item no. - single	Item no. - double
122	22,5	B303000211	B303000212
122	25	B303000221	B303000222
122	30	B303000231	B303000232
122	40	B303000241	B303000242
152	22,5	B303000511	B303000512
152	25	B303000521	B303000522
152	30	B303000531	B303000532
152	40	B303000541	B303000542
182	22,5	B303000811	B303000812
182	25	B303000821	B303000822
182	30	B303000831	B303000832
182	40	B303000841	B303000842
212	22,5	B303000111	B303000112
212	25	B303000121	B303000122
212	30	B303000131	B303000132
212	40	B303000141	B303000142

Crossbar

2 pcs. per bay.

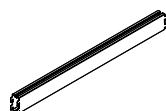

Module cm
75
90
100

Item no.
B3030027
B3030029
B3030021

Steel shelves

The LED lighting is mounted underneath standard steel top shelves and steel intermediate shelves with backedge. See pages 66-73.

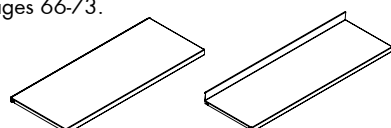



The Book LED lighting armature can be fitted on wooden top shelves and can be mounted over 1, 2 and 3 bays by use of connect fittings. Continuous runs also require connect fitting.

The armature is CE-approved and available in white and steel as standard. For other colours, please ask customer service.

Armature

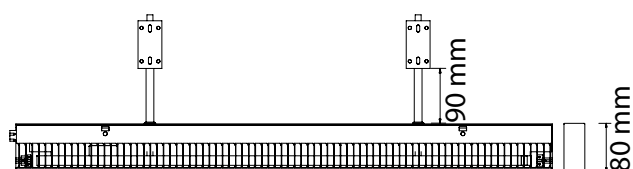

Model showing 2 bearing arms incl. light tube and louvre. Armature housing in aluminium.

Standard bearing arms

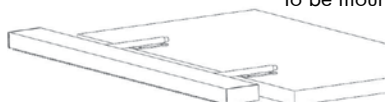

To be mounted on top of top shelf.

Front edge bearing arms

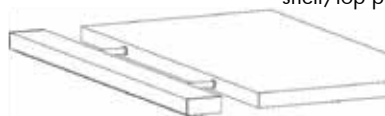

To be mounted on frontedge of predrilled top shelf/top plate (special request)

LIGHTING

BOOK LED LIGHTING

Below you will find a list of products needed when ordering lighting for 1, 2 or 3 bays. For 4 or more bays, you must use a combination of the armatures for 1, 2 or 3 bays by connecting the armatures with a connect fitting. Eg. for 10 bays, you can either use 5 x 2 bays (with 4 connect fittings) or 3 x 3 bays and 1 x 1 bay (with 3 connect fittings).

1 bay



Armature module 75 - W750 x D80 x H32 mm or
Armature module 90 - W900 x D80 x H32 mm or
Armature module 100 - W1005 x D80 x H32 mm

Item no.

B3900100750
B3900100900
B3900101005

Bearing arms, 2 pcs., standard or
Bearing arms, 2 pcs., front edge

B39001512
B39001522

End covers, 2 pcs.

B390011

2 bays

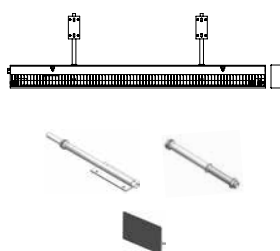

Armature module 75 + 75 - W1500 x D80 x H32 mm or
Armature module 90 + 90 - W1800 x D80 x H32 mm or
Armature module 90 + 100 - W1905 x D80 x H32 mm or
Armature module 100 + 100 - W2010 x D80 x H32 mm

Item no.

B3900101500
B3900101800
B3900101905
B3900102010

Bearing arms, 2 pcs., standard or
Bearing arms, 2 pcs., front edge

B39001512
B39001522

End covers, 2 pcs.

B390011

3 bays



Armature module 75 + 75 + 75 - W2250 x D80 x H32 mm or
Armature module 75 + 90 + 75 - W2400 x D80 x H32 mm or
Armature module 90 + 90 + 90 - W2700 x D80 x H32 mm or
Armature module 100 + 90 + 100 - W2910 x D80 x H32 mm or
Armature module 100 + 100 + 100 - W3015 x D80 x H32 mm

Item no.

B3900102250
B3900102400
B3900102700
B3900102910
B3900103015

Bearing arms, 3 pcs., standard or
Bearing arms, 3 pcs., front edge

B39001513
B39001523

End covers, 2 pcs.

B390011

Cable 3 x 1.5 mm², L2500 mm

Item no.

B390013

Connect fitting



Item no.

B390012



École Nationale des Ponts et Chaussées (ENPC), Champs sur Marne, France
60/30 Classic round steel shelving

60/30 CLASSIC ROUND STEEL SHELVING

CONFIGURATIONS - WITHOUT SHELVES

Double-sided shelving system with uprights and crossbars. For shelves, see page 168.

Height 92 cm

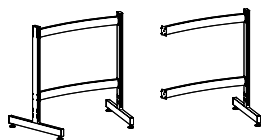
	Degree	Shelf depth cm	Item no.	
			Starter bay	Add-on bay
	26°	30	BB3031073600	BB3031173600
	18°	30	BB3031073800	BB3031173800

Height 122 cm

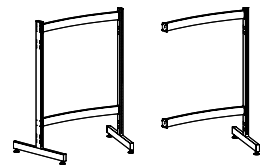
	Degree	Shelf depth cm	Item no.	
			Starter bay	Add-on bay
	26°	30	BB3031023600	BB3031123600
	18°	30	BB3031023800	BB3031123800

Height 152 cm

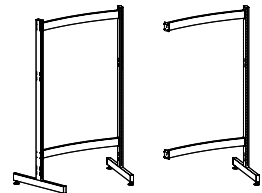
	Degree	Shelf depth cm	Item no.	
			Starter bay	Add-on bay
	26°	30	BB3031053600	BB3031153600
	18°	30	BB3031053800	BB3031153800

Height 182 cm

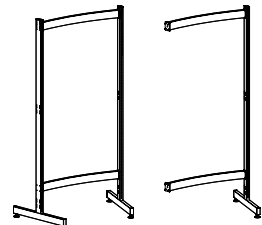
	Degree	Shelf depth cm	Item no.	
			Starter bay	Add-on bay
	26°	30	BB3031083600	BB3031183600
	18°	30	BB3031083800	BB3031183800

Height 212 cm

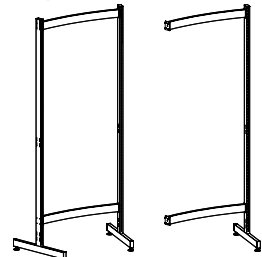
	Degree	Shelf depth cm	Item no.	
			Starter bay	Add-on bay
	26°	30	BB3031013600	BB3031113600
	18°	30	BB3031013800	BB3031113800

60/30 CLASSIC ROUND STEEL SHELVING

CONFIGURATIONS - WITH SHELVES - WITHOUT TOP SHELF

Complete double-sided shelving system with uprights, crossbars, shelves, brackets, galvanized safety clip and fittings (the safety clip is available in standard steel colours and can be ordered separately, see page 175). Shelves are rounded steel shelves with backedge. Number of shelves are calculated for optimal shelf spacing for fiction. A starter bay is delivered with one right and one left bracket per shelf. An add-on bay is delivered with a double bracket per shelf, which places the shelves in the same height as that of the starter bay.

Height 92 cm (2 shelves on each side)

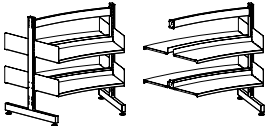
	Degree	Shelf depth cm	Item no.	
			Starter bay	Add-on bay
	Ø432 cm 26°	30	BB3031073620	BB3031173620
	Ø600 cm 18°	30	BB3031073820	BB3031173820

Height 122 cm (3 shelves on each side)

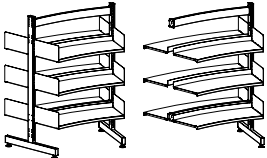
	Degree	Shelf depth cm	Item no.	
			Starter bay	Add-on bay
	Ø432 cm 26°	30	BB3031023630	BB3031123630
	Ø600 cm 18°	30	BB3031023830	BB3031123830

Height 152 cm (4 shelves on each side)

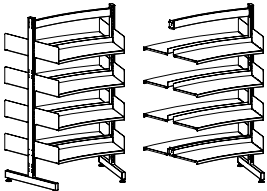
	Degree	Shelf depth cm	Item no.	
			Starter bay	Add-on bay
	Ø432 cm 26°	30	BB3031053640	BB3031153640
	Ø600 cm 18°	30	BB3031053840	BB3031153840

Height 182 cm (5 shelves on each side)

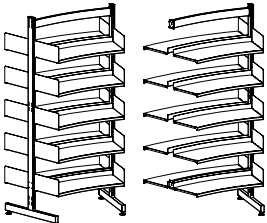
	Degree	Shelf depth cm	Item no.	
			Starter bay	Add-on bay
	Ø432 cm 26°	30	BB3031083650	BB3031183650
	Ø600 cm 18°	30	BB3031083850	BB3031183850

Height 212 cm (6 shelves on each side)

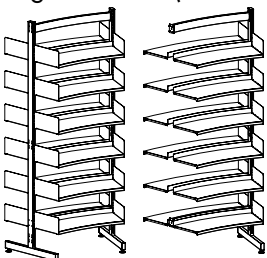
	Degree	Shelf depth cm	Item no.	
			Starter bay	Add-on bay
	Ø432 cm 26°	30	BB3031013660	BB3031113660
	Ø600 cm 18°	30	BB3031013860	BB3031113860

60/30 CLASSIC ROUND STEEL SHELVING

CONFIGURATIONS - WITH SHELVES AND TOP SHELVES

Complete double-sided shelving system with uprights, crossbars, shelves, top shelves, brackets, galvanized safety clip and fittings (the safety clip is available in standard steel colours and can be ordered separately, see page 175). Shelves are rounded steel shelves with backedge, top shelves are steel shelves without backedge. Number of shelves are calculated for optimal shelf spacing for fiction. A starter bay is delivered with one right and one left bracket per shelf. An add-on bay is delivered with a double bracket per shelf, which places the shelves in the same height as that of the starter bay.

Height 92 cm (2 shelves + top shelf on each side)

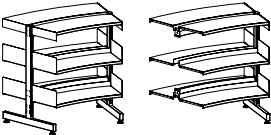
		Degree		Shelf depth	Item no.	Item no.
				cm	Starter bay	Add-on bay
	Ø432 cm	26°	30	BB3031073621	BB3031173621	
	Ø600 cm	18°	30	BB3031073821	BB3031173821	

Height 122 cm (3 shelves + top shelf on each side)

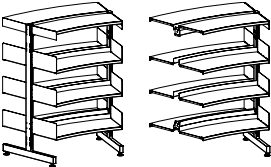
		Degree		Shelf depth	Item no.	Item no.
				cm	Starter bay	Add-on bay
	Ø432 cm	26°	30	BB3031023631	BB3031123631	
	Ø600 cm	18°	30	BB3031023831	BB3031123831	

Height 152 cm (4 shelves + top shelf on each side)

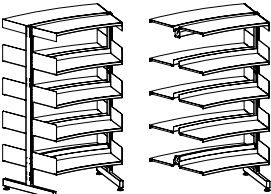
		Degree		Shelf depth	Item no.	Item no.
				cm	Starter bay	Add-on bay
	Ø432 cm	26°	30	BB3031053641	BB3031153641	
	Ø600 cm	18°	30	BB3031053841	BB3031153841	

Height 182 cm (5 shelves + top shelf on each side)

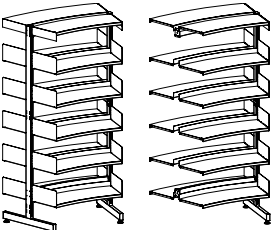
		Degree		Shelf depth	Item no.	Item no.
				cm	Starter bay	Add-on bay
	Ø432 cm	26°	30	BB3031083651	BB3031183651	
	Ø600 cm	18°	30	BB3031083851	BB3031183851	

Height 212 cm (6 shelves + top shelf on each side)

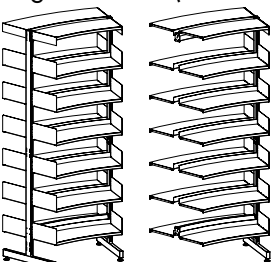
		Degree		Shelf depth	Item no.	Item no.
				cm	Starter bay	Add-on bay
	Ø432 cm	26°	30	BB3031013661	BB3031113661	
	Ø600 cm	18°	30	BB3031013861	BB3031113861	

ROUND SHELVES

ROUND STEEL SHELVES

See below for overview of standard round steel shelves:

B301500 - ROUND STEEL SHELF WITH STEEL BACKEDGE - 25 MM FRONTEDGE

Details:

- 26°/18°
- Depth 300 mm
- Steel backedge H47 mm
- Steel plate brackets
- Max. weight 80 kg.

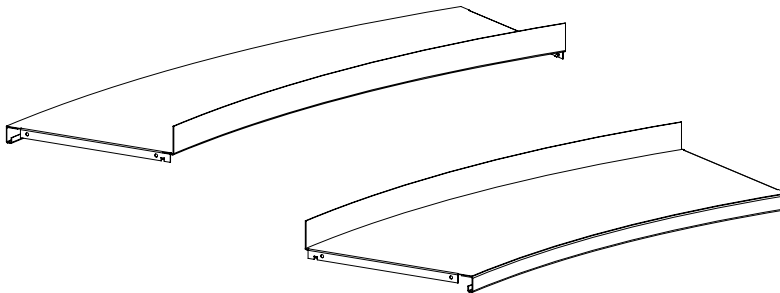

ROUND SHELVES

ROUND SINGLE-SIDED STEEL SHELF

Round steel shelf with steel backedge - with brackets

With one left and one right bracket.

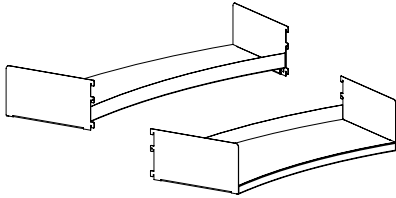

Degree	Shelf depth cm	Item no. Inner	Item no. Outer
26°	30	BB3030561	BB3030562
18°	30	BB3030581	BB3030582

Round steel shelf with steel backedge - without brackets

Shelves for starter bays must be ordered with left and right brackets. Shelves for add-on bays must be ordered with double bracket.

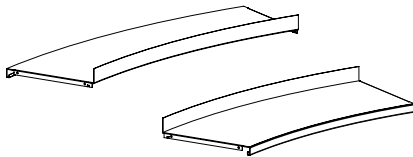

Degree	Shelf depth cm	Item no. Inner	Item no. Outer
26°	30	B301500613	B301500623
18°	30	B301500813	B301500823

Steel plate bracket for steel shelves with steel backedge

H15 cm.

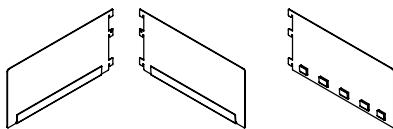

Type	Shelf depth cm	Item no.
Left	30	B30101437
Right	30	B30101438
Double	30	B30101439

ROUND SHELVES

ROUND STEEL TOP SHELVES

See below for overview of standard round steel top shelves:

B301502 - SINGLE-SIDED ROUND STEEL TOP SHELF - 25 MM FRONTEDGE

Details:

- 26°/18°
- Depth 300 mm
- Steel brackets
- Max. weight 25 kg.

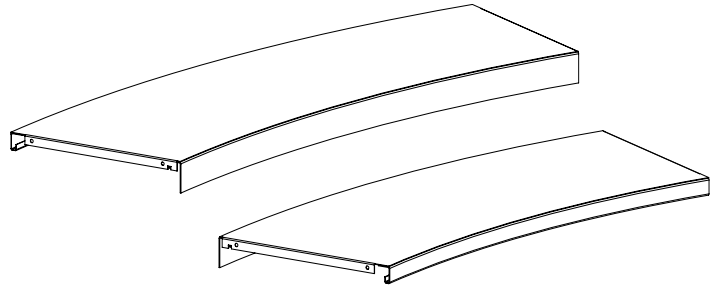

B301531 - DOUBLE-SIDED ROUND STEEL TOP SHELF - 25/47 MM FRONTEDGE

Details:

- 26°/18°
- Depth 660 mm
- Freestanding/outer/intermediate
- Steel brackets
- Max. weight 25 kg.

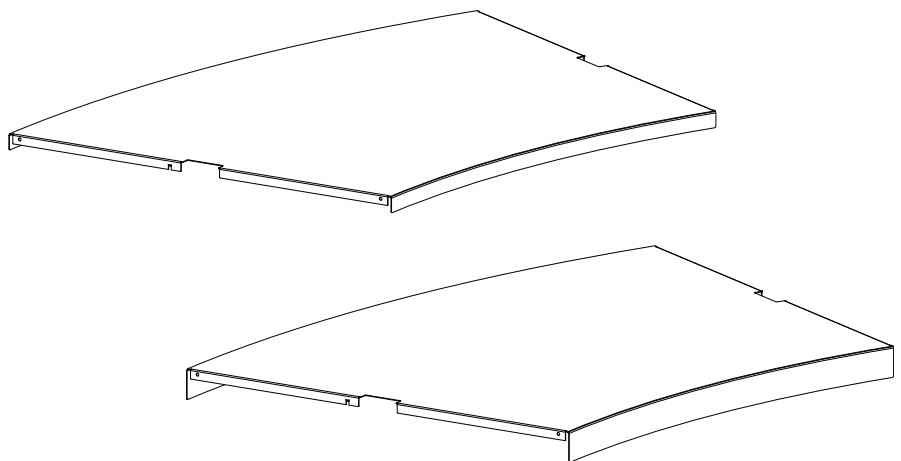

ROUND SHELVES

ROUND SINGLE-SIDED STEEL TOP SHELF

Round single-sided steel top shelf

Order 1 inner and 1 outer shelf per section. Shelves for starter bays must be ordered with left and right brackets. Shelves for add-on bays must be ordered with double bracket.

Degree	Shelf depth cm	Item no. Inner	Item no. Outer
26°	30	B301502613	B301502623
18°	30	B301502813	B301502823

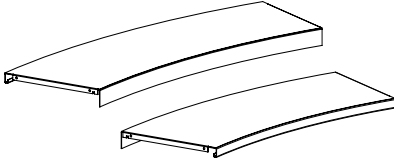

Steel bracket for round single-sided steel shelf

H7.5 cm. Max. load of 25 kg.

Type	Shelf depth cm	Item no.
Left	30	B30102437
Right	30	B30102438
Double	30	B30102439

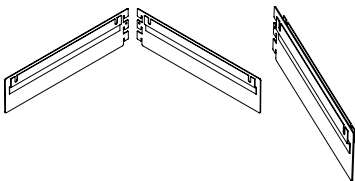

ROUND SHELVES

ROUND DOUBLE-SIDED STEEL TOP SHELF WITH BRACKETS

Double-sided steel top shelf with brackets - for 1 freestanding bay

2 left and 2 right brackets included.

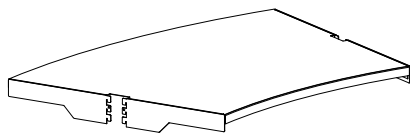
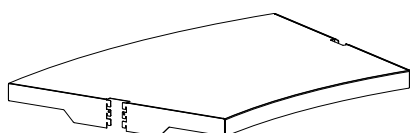
	Degree	Shelf depth cm	Front edge cm	Item no.
	26°	30	25	BB3030765125
	18°	30	25	BB3030785125
	26°	30	47	BB3030765147
	18°	30	47	BB3030785147

Double-sided steel top shelf with brackets - for 1 left, outer bay

1 left, 1 right and 1 double bracket included.

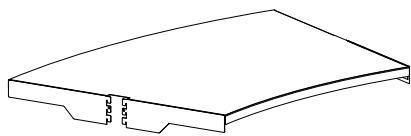
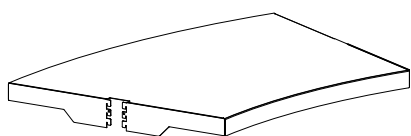
	Degree	Shelf depth cm	Front edge cm	Item no.
	26°	30	25	BB3030761125
	18°	30	25	BB3030781125
	26°	30	47	BB3030761147
	18°	30	47	BB3030781147

Double-sided steel top shelf with brackets - for 1 intermediate bay

2 double brackets included.

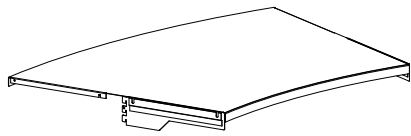
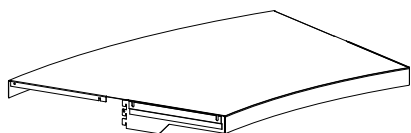
	Degree	Shelf depth cm	Front edge cm	Item no.
	26°	30	25	BB3030763125
	18°	30	25	BB3030783125
	26°	30	47	BB3030763147
	18°	30	47	BB3030783147

Double-sided steel top shelf with brackets - for 1 right, outer bay

1 left, 1 right and 1 double bracket included.

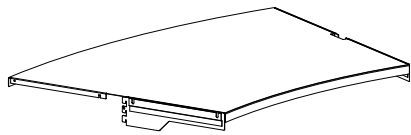
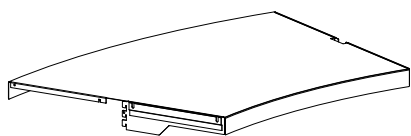
	Degree	Shelf depth cm	Front edge cm	Item no.
	26°	30	25	BB3030762125
	18°	30	25	BB3030782125
	26°	30	47	BB3030762147
	18°	30	47	BB3030782147

ROUND SHELVES

ROUND DOUBLE-SIDED STEEL TOP SHELF

Double-sided steel top shelf without brackets - for 1 freestanding bay

2 left and 2 right brackets to be ordered separately. See page 175.

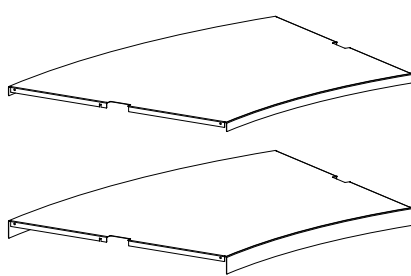

Degree	Shelf depth cm	Front edge cm
26°	30	25
18°	30	25
26°	30	47
18°	30	47

Item no.
B30153165125
B30153185125
B30153165147
B30153185147

Double-sided steel top shelf without brackets - for 1 left, outer bay

1 left, 1 right and 1 double brackets to be ordered separately. See page 175.

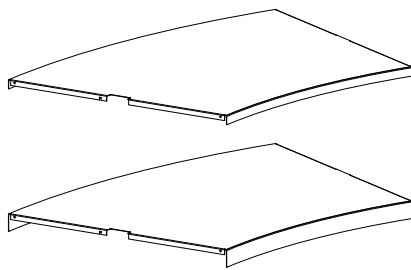

Degree	Shelf depth cm	Front edge cm
26°	30	25
18°	30	25
26°	30	47
18°	30	47

Item no.
B30153161125
B30153181125
B30153161147
B30153181147

Double-sided steel top shelf without brackets - for 1 intermediate bay

2 double brackets to be ordered separately. See page 175.

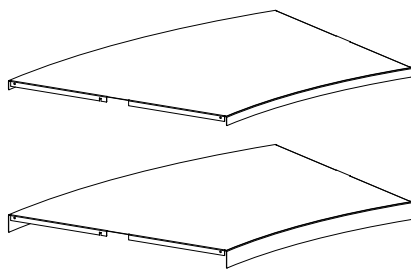

Degree	Shelf depth cm	Front edge cm
26°	30	25
18°	30	25
26°	30	47
18°	30	47

Item no.
B30153163125
B30153183125
B30153163147
B30153183147

Double-sided steel top shelf without brackets - for 1 right, outer bay

1 left, 1 right and 1 double brackets to be ordered separately. See page 175.

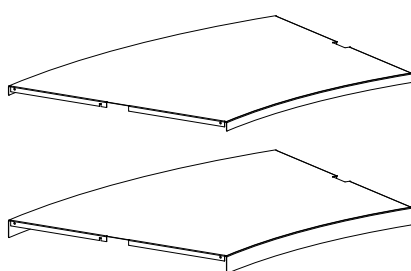

Degree	Shelf depth cm	Front edge cm
26°	30	25
18°	30	25
26°	30	47
18°	30	47

Item no.
B30153162125
B30153182125
B30153162147
B30153182147



COMPONENTS FOR ROUND STEEL SHELVES

BRACKETS, SHELF STRENGTHENER AND SAFETY CLIPS

Steel bracket for steel top shelf B301531

Max. load of 25 kg.

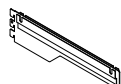
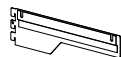
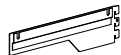

Type	Shelf depth cm	Item no.
Left	30	B30102937
Right	30	B30102938
Double	30	B30102939

Shelf strengthener

Max. load on round shelf is 30 kg.

Max. load on round shelf with shelf strengthener is 80 kg.

Degree	Shelf depth cm	Item no. Inner	Item no. Outer
26°	30	B301540613	B301540623
18°	30	B301540813	B301540823



Safety clip

Two used per outer shelf. Hooks into the upright to prevent the shelf from possible tipping.

Finish	Item no.
Painted	B301530

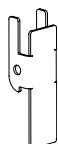

ROUND SHELVES

FSC DOUBLE-SIDED ROUND LONDON WOODEN TOP PLATE

See below for overview of standard round wooden top plate:

B302134 - FSC DOUBLE-SIDED ROUND LONDON WOODEN TOP PLATE - 30 MM FRONTEDGE

Details:

- 26°/18°
- Depth 300 mm
- Steel plate brackets
- Max. weight 25 kg.

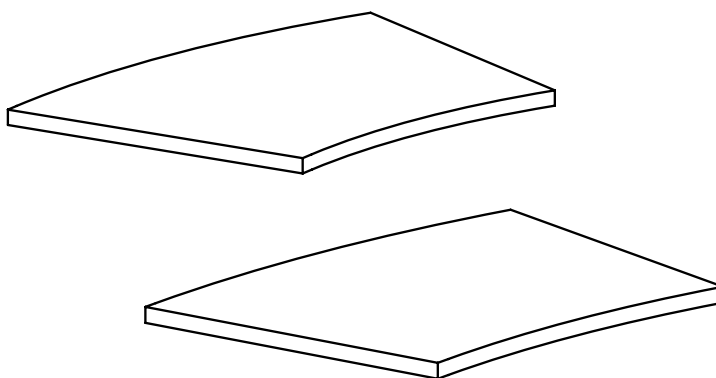

ROUND SHELVES

FSC DOUBLE-SIDED ROUND LONDON WOODEN TOP PLATE

FSC double-sided round London wooden top plate with brackets

D66 cm, 30 mm front edge.
Incl. brackets.

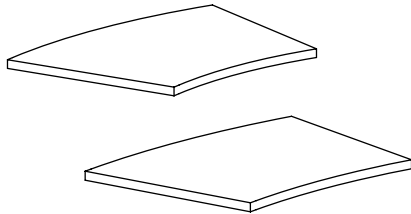

Degree	Type	Item no.
26°	Freestanding	B302137365
18°	Freestanding	B302137385
26°	Left	B302137361
18°	Left	B302137381
26°	Right	B302137362
18°	Right	B302137382
26°	Intermediate	B302137363
18°	Intermediate	B302137383

Bracket for FSC double-sided London round wooden top plate

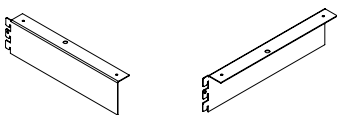

Type	Item no.
Left	B30120038
Right	B30120039

COMPONENTS FOR ROUND SHELVING

UPRIGHT AND CROSSBAR

Upright

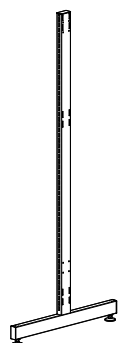

Height cm	Shelf depth cm	Item no.
92	30	B3015197
122	30	B3015192
152	30	B3015195
182	30	B3015198
212	30	B3015191

Round crossbar

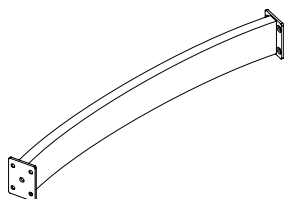

Degree	Shelf depth cm	Item no.
26°	30	B3015106
18°	30	B3015108

COMPONENTS FOR ROUND SHELVING

CASTORS AND PLINTHS

Castors

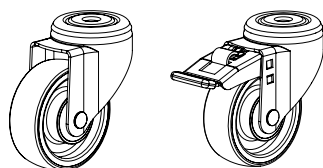

Type

Item no.

Without brakes
With brakes

B3060000
B3060001

Round steel plinth

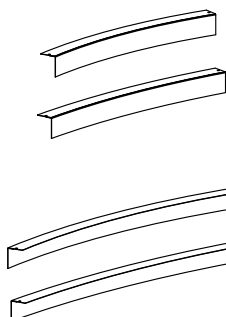

Degree

Curve

Item no.

26°
18°

Inner
Inner

B30152761
B30152781

26°
18°

Outer
Outer

B30152762
B30152782

Round castor frame set with hidden castors and steel plinth

A set of 2 frames, 4 x Ø35 mm castors without brakes and 2 steel plinths. Fittings included. Holes must be predrilled in the foot of the upright B301519 for installation.

Degree

Item no.

26°
18°

B3015506
B3015508

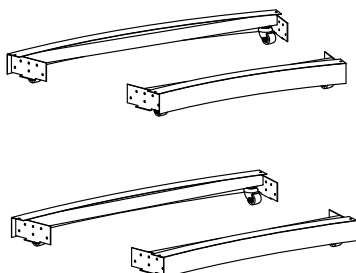



PANELS FOR ROUND SHELVING

WOODEN END PANELS

FSC painted wooden end panel - double-sided

19 mm front edge. Incl. fittings. These end panels are not compatible with hidden castor frames.



Height cm	Shelf depth cm	Item no.
92	30	B3016657395
122	30	B3016652395
152	30	B3016655395
182	30	B3016658395
199.5	30	B3016659395
212	30	B3016651395

FSC veneer wooden end panel - double-sided

19 mm front edge. Incl. fittings. These end panels are not compatible with hidden castor frames.

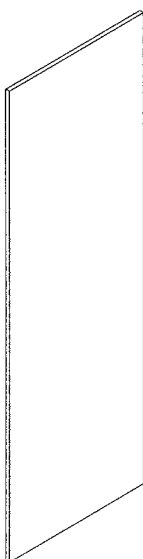

Height cm	Shelf depth cm	Item no.
92	30	B3016657391
122	30	B3016652391
152	30	B3016655391
182	30	B3016658391
199.5	30	B3016659391
212	30	B3016651391

PANELS FOR ROUND SHELVING

WOODEN SLAT END PANELS

FSC painted wooden slat end panel - double-sided

22 mm front edge. Incl. fittings. These end panels are not compatible with hidden castor frames.

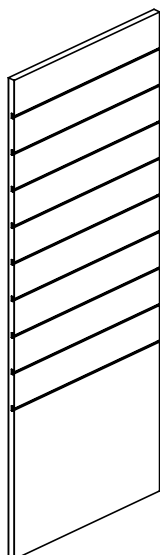

Height cm	Shelf depth cm	Item no.
92	30	B3016747395
122	30	B3016742395
152	30	B3016745395
182	30	B3016748395
212	30	B3016741395

FSC veneer wooden slat end panel - double-sided

22 mm front edge. Incl. fittings. These end panels are not compatible with hidden castor frames.

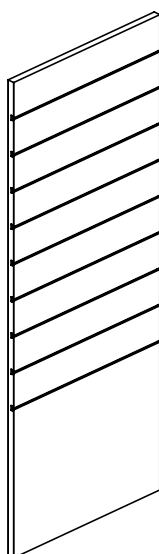

Height cm	Shelf depth cm	Item no.
92	30	B3016747391
122	30	B3016742391
152	30	B3016745391
182	30	B3016748391
212	30	B3016741391

PANELS FOR ROUND SHELVING

LONDON WOODEN END PANELS

FSC painted London wooden end panel for steel top shelf - double-sided

30 mm front edge. To be used with steel top shelf, see page 170. Incl. fittings.

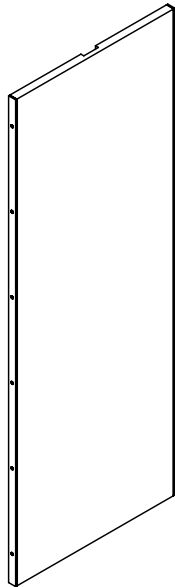

Height cm	Shelf depth cm	Item no.
92	30	B3021257392
122	30	B3021252392
152	30	B3021255392
182	30	B3021258392
212	30	B3021251392

FSC painted London wooden end panel for wooden overlaying top plate - double-sided

30 mm front edge. To be used with London wooden overlaying top, see page 176. Incl. fittings.

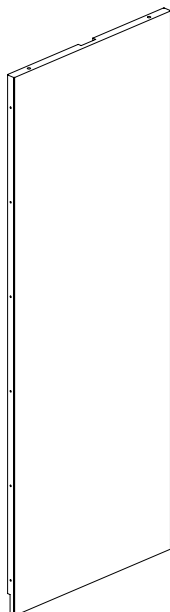

Height cm	Shelf depth cm	Item no.
92	30	B3021257391
122	30	B3021252391
152	30	B3021255391
182	30	B3021258391
212	30	B3021251391

PANELS FOR ROUND SHELVING

PERFORATED STEEL END PANEL

Perforated steel end panels - double-sided

45 mm front edge. Two A5 acrylic covers for signage and fittings included.
Hole size Ø4,5 mm.

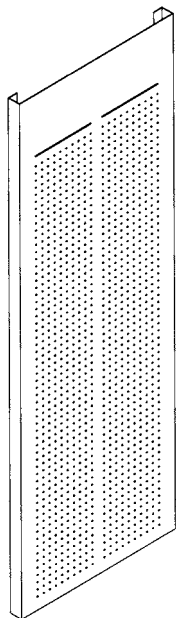

Height cm	Shelf depth cm	Item no.
92	30	B301600739
122	30	B301600239
152	30	B301600539
182	30	B301600839
199.5	30	B301600939
212	30	B301600139

PANELS FOR ROUND SHELVING

FITTINGS FOR PANELS

Fittings for wooden end panel

Type	Heights < 152 cm Item no.	Heights > =152 cm Item no.
Left	B30165227	B30165217
Right	B30165228	B30165218
Double	B30165229	B30165219

Fittings for wooden display end panel

Type	Item no. Heights < 152 cm	Item no. Heights > =152 cm
Left	B30167227	B30167217
Right	B30167228	B30167218
Double	B30167229	B30167219



END PANEL BAYS

FOR ROUND DOUBLE-SIDED 60/30 CLASSIC STEEL SHELVING

The following pages will show basic configurations of end panel bays for double-sided 60/30 Classic Steel Shelving system.



END PANEL BAYS

FOR ROUND DOUBLE-SIDED 60/30 CLASSIC STEEL SHELVING

FSC-approved end panel bay with wooden top shelf, wooden panels, wooden bottom shelf and adjustable feet. For shelves, see page 194.

Height 92 cm

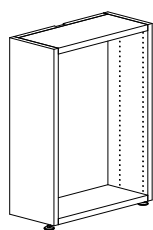

Depth of shelving system - cm	Width of end panel bay - cm	Depth of end panel bay - cm	Item no. Painted	Item no. Veneer
30/30	61,8	25	BB30132722005	BB30132722001
30/30	61,8	30	BB30132723005	BB30132723001

Height 122

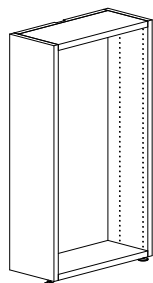

Depth of shelving system - cm	Width of end panel bay - cm	Depth of end panel bay - cm	Item no. Painted	Item no. Veneer
30/30	61,8	25	BB30132222005	BB30132222001
30/30	61,8	30	BB30132223005	BB30132223001

Height 152 cm

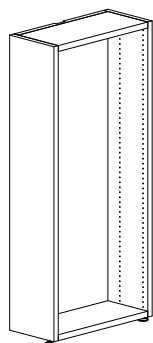

Depth of shelving system - cm	Width of end panel bay - cm	Depth of end panel bay - cm	Item no. Painted	Item no. Veneer
30/30	61,8	25	BB30132522005	BB30132522001
30/30	61,8	30	BB30132523005	BB30132523001

END PANEL BAYS

FOR ROUND DOUBLE-SIDED 60/30 CLASSIC STEEL SHELVING

FSC-approved end panel bay with wooden top shelf, wooden panels, wooden bottom shelf and adjustable feet. For shelves, see page 194.

Height 182 cm

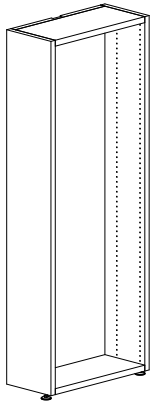

Depth of shelving system - cm	Width of end panel bay - cm	Depth of end panel bay - cm	Item no. Painted	Item no. Veneer
30/30	61,8	25	BB30132822005	BB30132822001
30/30	61,8	30	BB30132823005	BB30132823001

Height 212 cm

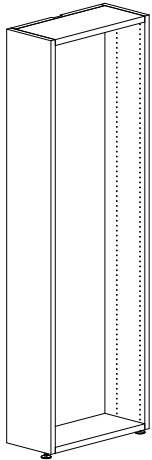

Depth of shelving system - cm	Width of end panel bay - cm	Depth of end panel bay - cm	Item no. Painted	Item no. Veneer
30/30	61,8	25	BB30132122005	BB30132122001
30/30	61,8	30	BB30132123005	BB30132123001

END PANEL BAYS

FOR ROUND DOUBLE-SIDED SHELVING WITH AJDUSTABLE FEET & LONDON WOODEN TOP PLATE

FSC-approved end panel bay with overlaying London wooden top plate, wooden panels, wooden bottom shelf and adjustable feet. For shelves, see page 194.

Height 92 cm

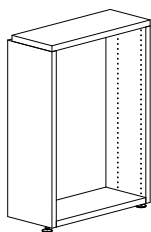

Depth of shelving system - cm	Width of end panel bay - cm	Depth of end panel bay - cm	Item no. Painted	Item no. Veneer
30/30	61,8	25	BB30133722005	BB30133722001
30/30	61,8	30	BB30133723005	BB30133723001

Height 122

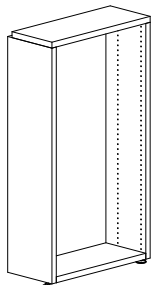

Depth of shelving system - cm	Width of end panel bay - cm	Depth of end panel bay - cm	Item no. Painted	Item no. Veneer
30/30	61,8	25	BB30133222005	BB30133222001
30/30	61,8	30	BB30133223005	BB30133223001

Height 152 cm

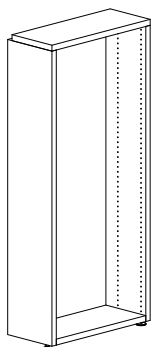

Depth of shelving system - cm	Width of end panel bay - cm	Depth of end panel bay - cm	Item no. Painted	Item no. Veneer
30/30	61,8	25	BB30133522005	BB30133522001
30/30	61,8	30	BB30133523005	BB30133523001

END PANEL BAYS

FOR ROUND DOUBLE-SIDED SHELVING WITH ADJUSTABLE FEET & LONDON WOODEN TOP PLATE

FSC-approved end panel bay with overlaying London wooden top plate, wooden panels, wooden bottom shelf and adjustable feet. For shelves, see page 194.

Height 182 cm

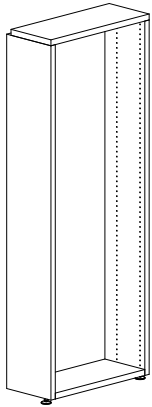

Depth of shelving system - cm	Width of end panel bay - cm	Depth of end panel bay - cm	Item no. Painted	Item no. Veneer
30/30	61,8	25	BB30133822005	BB30133822001
30/30	61,8	30	BB30133823005	BB30133823001

Height 212 cm

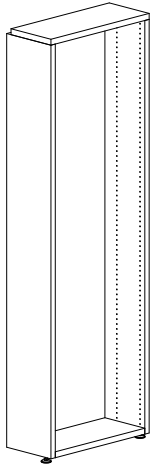

Depth of shelving system - cm	Width of end panel bay - cm	Depth of end panel bay - cm	Item no. Painted	Item no. Veneer
30/30	61,8	25	BB30133122005	BB30133122001
30/30	61,8	30	BB30133123005	BB30133123001

END PANEL BAYS

FOR ROUND DOUBLE-SIDED SHELVING WITH CASTORS

FSC-approved end panel bay with wooden top shelf, wooden panels, wooden bottom shelf and castors. For shelves, see page 194.

Height 92 cm

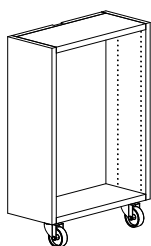

Depth of shelving system - cm	Width of end panel bay - cm	Depth of end panel bay - cm	Item no. Painted	Item no. Veneer
30/30	61,8	25	BB30136722005	BB30136722001
30/30	61,8	30	BB30136723005	BB30136723001

Height 122

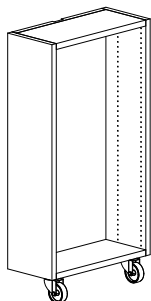

Depth of shelving system - cm	Width of end panel bay - cm	Depth of end panel bay - cm	Item no. Painted	Item no. Veneer
30/30	61,8	25	BB30136222005	BB30136222001
30/30	61,8	30	BB30136223005	BB30136223001

Height 152 cm

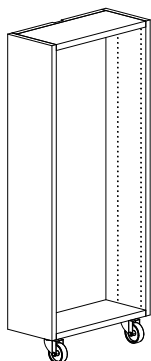

Depth of shelving system - cm	Width of end panel bay - cm	Depth of end panel bay - cm	Item no. Painted	Item no. Veneer
30/30	61,8	25	BB30136522005	BB30136522001
30/30	61,8	30	BB30136523005	BB30136523001

END PANEL BAYS

FOR ROUND DOUBLE-SIDED SHELVING WITH CASTORS & LONDON WOODEN TOP PLATE

FSC-approved end panel bay with overlaying London wooden top plate, wooden panels, wooden bottom shelf and castors. For shelves, see page 194.

Height 92 cm

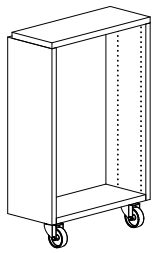

Depth of shelving system - cm	Width of end panel bay - cm	Depth of end panel bay - cm	Item no. Painted	Item no. Veneer
30/30	61,8	25	BB30137222005	BB30137222001
30/30	61,8	30	BB30137223005	BB30137223001

Height 122

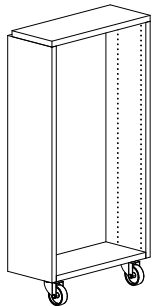

Depth of shelving system - cm	Width of end panel bay - cm	Depth of end panel bay - cm	Item no. Painted	Item no. Veneer
30/30	61,8	25	BB30137522005	BB30137522001
30/30	61,8	30	BB30137523005	BB30137523001

Height 152 cm

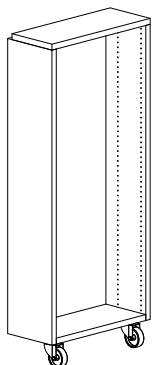

Depth of shelving system - cm	Width of end panel bay - cm	Depth of end panel bay - cm	Item no. Painted	Item no. Veneer
30/30	61,8	25	BB30137722005	BB30137722001
30/30	61,8	30	BB30137723005	BB30137723001

END PANEL BAYS

STEEL SHELVES

Steel shelf with steel backedge for backedge book support

Steel backedge 47 mm.
Brackets must be ordered
separately.

Depth of shelving
system - cm

Depth of end
panel bay - cm

Width of shelf
- cm

Item no.

30/30

25

61,3

B30118222

30/30

30

61,3

B30118223

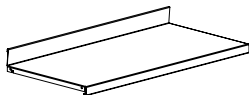

Bracket for steel shelves with steel backedge

* Can be used for D25 and
30 cm shelves.

Type

Depth of end
panel bay - cm

Item no.

Left

25

B78300128

Right

25

B78300129

Left*

30

B78300138

Right*

30

B78300139

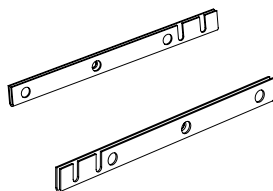

45°/60° sloping steel shelf

With fittings.

Depth of shelving
system - cm

Depth of end
panel bay - cm

Item no.

30/30

25

B30118622

30/30

30

B30118623





LOCATIONS

WE ARE LIBRARY PEOPLE®



DENMARK

Lammhults Biblioteksdesign A/S
Dalbækvej 1
6670 Holsted

bci@bci.dk
www.bci.dk

FRANCE

BC Intérieur Sarl
6 allée Kepler
77420 Champs sur Marne

bci@bcinterieur.com
www.bcinterieur.com

BELGIUM

SBNL - Schulz Benelux BVBA
Appelweg 94 C
3221 Holsbeek

info@sbnl.be
www.sbnl.be

SWEDEN

Lammhults Biblioteksdesign AB
Odlarevägen 16
226 60 Lund

eurobib@eurobib.se
www.eurobib.se

GERMANY

Schulz Speyer Bibliothekstechnik AG
Hafenstraße 2
67346 Speyer

sales@schulzspeyer.de
www.schulzspeyer.de

UNITED KINGDOM

thedesignconcept Ltd.
The Old Bakery,
10 Greenless Road
Cambuslang Belgrave Street
Glasgow G72 8JJ

info@thedesignconcept.co.uk
www.thedesignconcept.co.uk

NORWAY

BS Eurobib AS
Alf Bjerckes Vei 20
0582 Oslo

post@bseurobib.no
www.bseurobib.no