

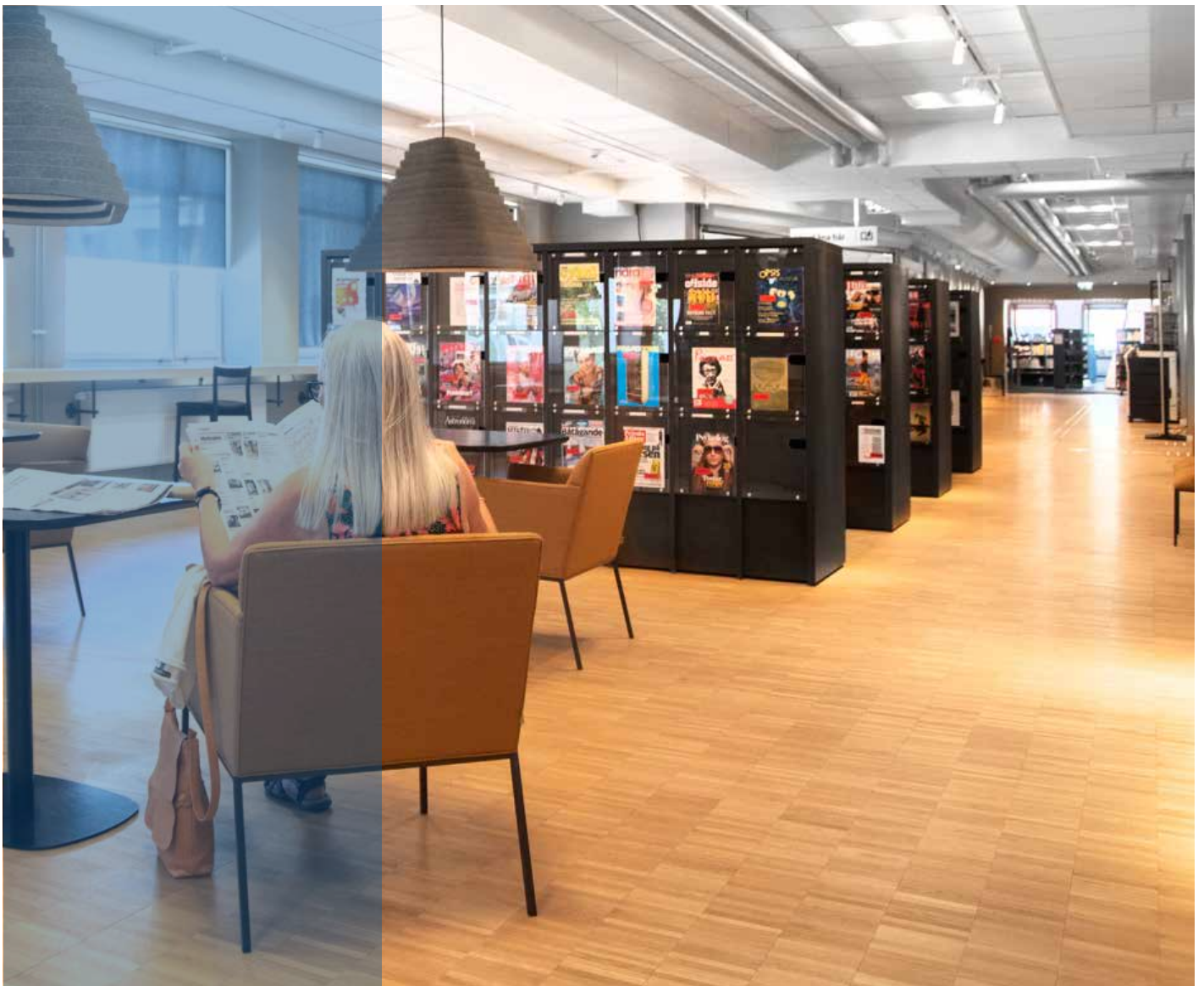

ORDRUP & SINGLES

01.01.2024



ORDRUP & SINGLES

The magazine display and storage shelving systems become more and more popular, not only in the library but also in various public areas where magazines need to be exposed and stored in a user friendly way. With our two different systems you can organize your magazines in an easy-to-find way and at the same time logically store older versions of the magazines.

These elegant and streamlined displays fit in nicely with several of our main products; Lingo, Box and 60/30 Steel Shelving with London panel and top shelves. Use the magazine display and storage shelving as a piece of furniture on its own or as a room divider to help create just the right atmosphere.



TECHNICAL SPECIFICATIONS..... 5

DESIGN OPTIONS..... 6

CONFIGURATIONS

ORDRUP DISPLAY 8

Single-sided configurations - painted / veneer 10

Double-sided configurations - painted / veneer 11

ORDRUP SQUARE 12

Configurations - painted 14

Configurations - veneer 15

SINGLES DISPLAY 16

Single-sided configurations - painted / veneer 18

Double-sided configurations - painted / veneer 19



TECHNICAL SPECIFICATIONS

WOODEN COMPONENTS

DENSITY

Particle board has a density of 600-700 kg/m³

Block board has a density of 602 kg/m³ (+/- 2 %)

MDF has a density of 700 kg/m³ (+/- 5-7 %)

VENEERED WOODEN COMPONENTS

are mainly lacquered with UV-lacquer. See Design Options for veneer specifications.

VENEERED PANELS

are made of 22 mm particle board and are veneered with 0.6 mm veneer. All edges on the panels have a 2 mm veneer edge. The panels have two holes in the bottom for adjustable feet.

VENEERED BACK PANELS

are made of 16 mm particle board and are veneered with 0.6 mm veneer. The horizontal edges have a 2 mm veneer edge. The vertical edges are not banded, as they are not exposed after assembly of the back panel.

VENEERED SHELVES

are made of 22 mm block board and are veneered with 0.6 mm veneer. The front and back edges have a 2 mm veneer edge.

VENEERED PLINTHS

are made of 19 mm particleboard and are veneered with 0.6 mm veneer on the front. The top edge have a 2 mm veneer edge.

PAINTED WOODEN COMPONENTS

are made of MDF (medium density fibre board) which is painted with acid lacquer. Standard components have gloss 20 - 30. See Design Options for colour specifications.

PAINTED PANELS

are made of 22 mm MDF. The panels have a wooden based edge on the lower edge to strengthen the end panel and have two holes in the bottom for adjustable feet.

PAINTED BACK PANELS

are made of 16 mm MDF and are painted on all sides and edges.

PAINTED SHELVES

are made of 22 mm blockboard with 3 mm MDF.

PAINTED TOP SHELVES

are made of 22 mm MDF.

PAINTED PLINTHS

are made of 19 mm MDF.

DESIGN OPTIONS

WOODEN COMPONENTS - PAINTED

A PRICE GROUP - BASIS PRICE

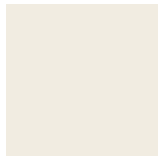

A01
Pure white
RAL 9010
Gloss 20-30



A02
Oyster white
RAL 1013
Gloss 20-30

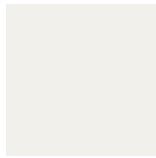

A03
Traffic white
RAL 9016
Gloss 20-30



A04
Traffic yellow
RAL 1023
Gloss 20-30



A05
Sun yellow
RAL 1037
Gloss 20-30



A06
Signal orange
RAL 2010
Gloss 20-30



A07
Pearl orange
RAL 2013
Gloss 20-30



A08
Flame red
RAL 3000
Gloss 20-30



A09
Ruby red
RAL 3003
Gloss 20-30



A21
Reseda green
RAL 6011
Gloss 20-30



A22
Moss green
RAL 6005
Gloss 20-30



A26
Fir green
RAL 6009
Gloss 20-30



A10
Pigeon blue
RAL 5014
Gloss 20-30



A11
Ocean blue
RAL 5020
Gloss 20-30



A12
Steel blue
RAL 5011
Gloss 20-30



A13
Light grey
RAL 7035
Gloss 20-30



A14
White aluminium
RAL 9006
Gloss 20-30



A31
Grey aluminium
RAL 9007
Gloss 20-30



A15
Dusty grey
RAL 7037
Gloss 20-30



A16
Traffic grey
RAL 7043
Gloss 20-30



A17
Basalt grey
RAL 7012
Gloss 20-30



A18
Slate grey
RAL 7015
Gloss 20-30



A19
Anthracite grey
RAL 7016
Gloss 20-30



A25
Jet black
RAL 9005
Gloss 20-30

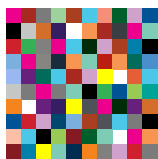

Any RAL/NCS colour
Gloss 20-30

Note:

- The above selection of colours match our steel colours. Note that you can order any RAL/NCS colour without surcharge.
- A surcharge for colours with "metallic" look or different surface textures must be expected, please contact Customer Service.

DESIGN OPTIONS

WOODEN COMPONENTS - VENEER

A PRICE GROUP - BASIS PRICE



55
Light steamed
beech



66
Oak



67
Maple



68
Ash



69
Birch

Note:

- The wooden veneers can also be stained for a surcharge, please contact Customer Service. Samples will be forwarded for approval.



Sundby Public Library, Denmark
Ordrup Display

ORDRUP DISPLAY

The Ordrup display is a combined magazine display and storage unit with panels and cabinet doors with acrylic display. The end panel comes with a flat front edge. Note that the height of the plinth is different for all three shelving heights.

Behind the cabinet doors with acrylic display are compartments providing A4 vertical storage boxes for older versions of the magazines.

HEIGHTS

Ordrup Display comes in 3 heights;
152, 182 and 212 cm.
Heights include adjustable feet (max. 2 cm).

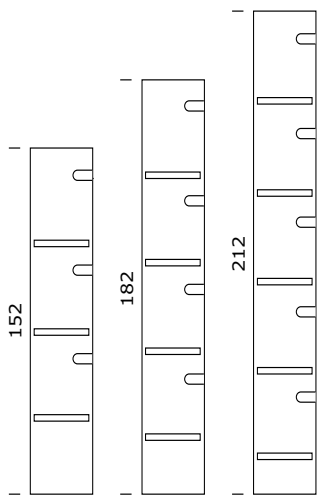

WIDTHS

The bays are available as starter and add-on bays.
A starter bay has two outside panels while an
add-on bay has one intermediate panel.

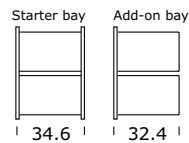

INNER COMPARTMENT

The inner compartment has the following size:
Height: 33,5 cm
Width: 30,2 cm
Depth: 30,0 cm

DEPTHS

The panels come in 2 depths;
36 cm for 30 cm deep shelves (single-sided)
69 cm for 2 x 30 cm deep shelves (double-sided)

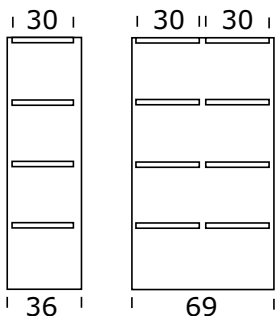

ACRYLIC FRONT

The acrylic front can take magazines up to the following
size:

Height: 32,5 cm
Width: 27,2 cm
Depth: 0,7 cm



ORDRUP

SINGLE-SIDED - VENEER & PAINTED

Complete shelving system with panels, full back, plinth, doors with acrylic display and cabinet protection pads, shelves, top shelf and fittings.

Height 152 cm (3 doors with acrylic display and 3 storage shelves and top shelf)

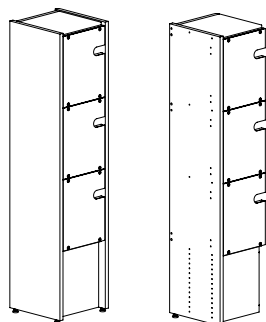

Bay	Surface	Item no.
Starter	Painted	BB78800531
Starter	Veneer	BB78820531ZZZZZ1
Add-on	Painted	BB78801531
Add-on	Veneer	BB78821531ZZZZZ1

Height 182 cm (4 doors with acrylic display and 4 storage shelves and top shelf)

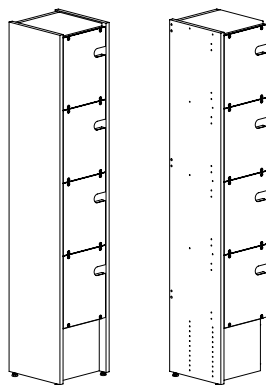

Surface	Surface	Item no.
Starter	Painted	BB78800831
Starter	Veneer	BB78820831ZZZZZ1
Add-on	Painted	BB78801831
Add-on	Veneer	BB78821831ZZZZZ1

Height 212 cm (5 doors with acrylic display and 5 storage shelves and top shelf)

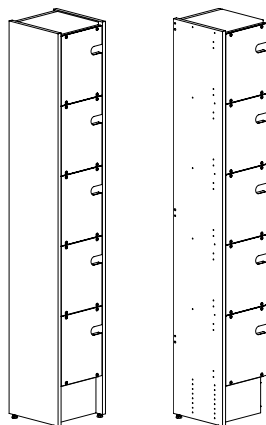

Surface	Surface	Item no.
Starter	Painted	BB78800131
Starter	Veneer	BB78820131ZZZZZ1
Add-on	Painted	BB78801131
Add-on	Veneer	BB78821131ZZZZZ1

Complete shelving system with panels, full back, plinth, doors with acrylic display and cabinet protection pads, shelves, top shelves and fittings.

Height 152 cm (3 doors with acrylic display and 3 storage shelves and top shelf on each side)

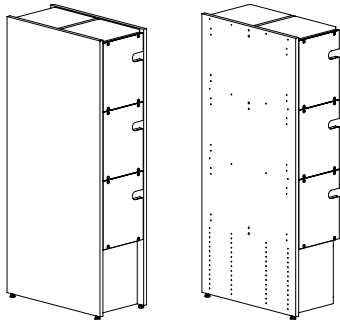

Surface	Surface	Item no.
Starter	Painted	BB78800532
Starter	Veneer	BB78820532ZZZZZ1
Add-on	Painted	BB78801532
Add-on	Veneer	BB78821532ZZZZZ1

Height 182 cm (4 doors with acrylic display and 4 storage shelves and top shelf on each side)

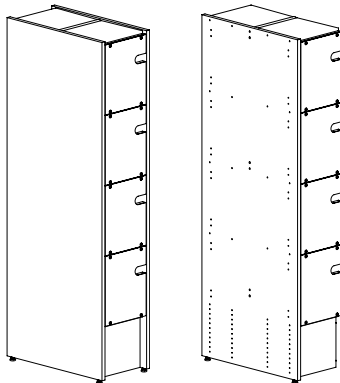

Surface	Surface	Item no.
Starter	Painted	BB78800832
Starter	Veneer	BB78820832ZZZZZ1
Add-on	Painted	BB78801832
Add-on	Veneer	BB78821832ZZZZZ1

Height 212 cm (5 doors with acrylic display and 5 storage shelves and top shelf on each side)

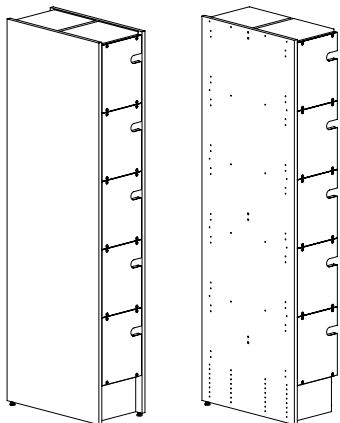

Surface	Surface	Item no.
Starter	Painted	BB78800132
Starter	Veneer	BB78820132ZZZZZ1
Add-on	Painted	BB78801132
Add-on	Veneer	BB78821132ZZZZZ1



Dokk1 Public Library, Århus, Denmark
Ordrup Square

ORDRUP SQUARE

The following pages will show basic configurations of Ordrup Square.

Ordrup Square is a combined magazine display and storage unit on castors. It is based on Slimline upright panels with end panels and cabinet doors with acrylic display. Behind the cabinet doors with acrylic display are compartments providing A4 vertical storage boxes for older versions of the magazines. The end panel comes with a 4 mm flat front edge of solid wood. The top plate can also serve as a display or play area, depending on the height of the furniture.

All standard models are equipped with 8 castors, so you can move the unit to the position you want. The end panels are ideal for graphics and signage which can emphasize a theme, a classification or general information.

HEIGHTS

The shelving system comes in 4 heights (with castors Ø7.5 cm); 92 (105.2), 122 (135.2), 152 (165.2) and 182 (195.2) cm.

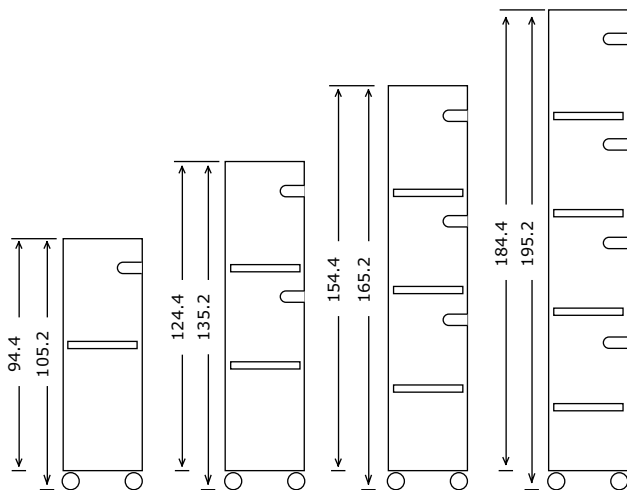

WIDTHS

The shelving system comes with 3 widths; 1, 2 or 3 columns. The total width of the unit depends on the amount of columns.

1 column

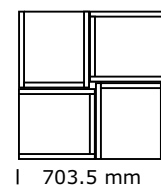

2 columns

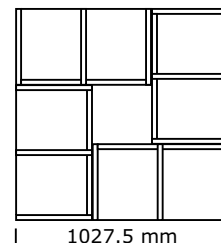

3 columns

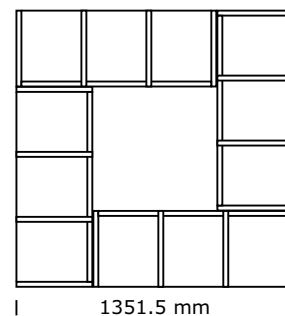

DEPTHS

The depth of the Ordrup Square is 36 cm.

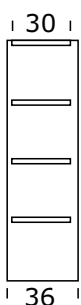

ORDRUP SQUARE

CONFIGURATIONS - PAINTED

A complete square shelving with end panels, full back, top and bottom plate, doors with acrylic display and cabinet protection pads, shelves and fittings. There are 8 castors in total (2 with brake). The maximum load is 600 kg.

Height 92 (105.2 cm) - with 1 cupboard in height

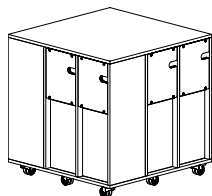

Type	Coloumns	Total width cm	Item no.
Painted	1	703.5	BB78840715
Painted	2	1027.5	BB78840725
Painted	3	1351.5	BB78840735

Height 122 (135.2 cm) - with 2 cupboards in height

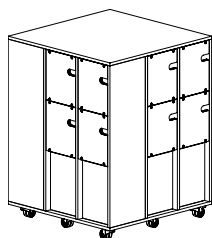

Type	Coloumns	Total width cm	Item no.
Painted	1	703.5	BB78840215
Painted	2	1027.5	BB78840225
Painted	3	1351.5	BB78840235

Height 152 (165.2 cm) - with 3 cupboards in height

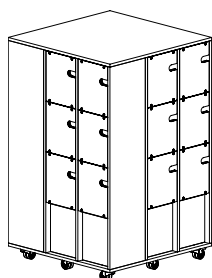

Type	Coloumns	Total width cm	Item no.
Painted	1	703.5	BB78840515
Painted	2	1027.5	BB78840525
Painted	3	1351.5	BB78840535

Height 182 (195.2 cm) - with 4 cupboards in height

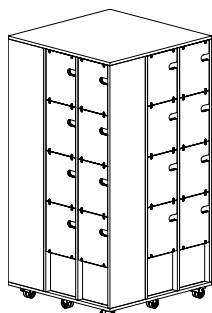

Type	Coloumns	Total width cm	Item no.
Painted	-	-	
Painted	2	1027.5	BB78840825
Painted	3	1351.5	BB78840835

ORDRUP SQUARE

CONFIGURATIONS - VENEER

A complete square shelving with end panels, full back, top and bottom plate, doors with acrylic display and cabinet protection pads, shelves and fittings. There are 8 castors in total (2 with brake). The maximum load is 600 kg.

Height 92 (105.2 cm) - with 1 cupboard in height

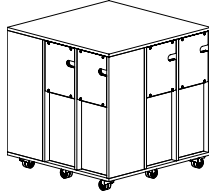

Type	Coloumns	Total width cm	Item no.
Veneer	1	703.5	BB78840711
Veneer	2	1027.5	BB78840721
Veneer	3	1351.5	BB78840731

Height 122 (135.2 cm) - with 2 cupboards in height

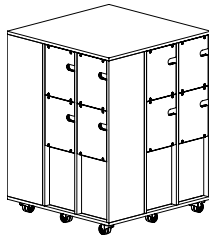

Type	Coloumns	Total width cm	Item no.
Veneer	1	703.5	BB78840211
Veneer	2	1027.5	BB78840221
Veneer	3	1351.5	BB78840231

Height 152 (165.2 cm) - with 3 cupboards in height

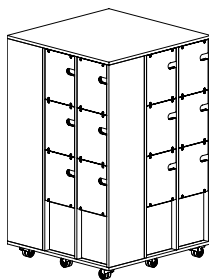

Type	Coloumns	Total width cm	Item no.
Veneer	1	703.5	BB78840511
Veneer	2	1027.5	BB78840521
Veneer	3	1351.5	BB78840531

Height 182 (195.2 cm) - with 4 cupboards in height

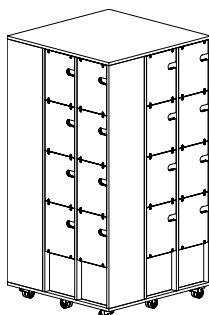

Type	Coloumns	Total width cm	Item no.
Veneer	-	703.5	
Veneer	2	1027.5	BB78840821
Veneer	3	1351.5	BB78840831

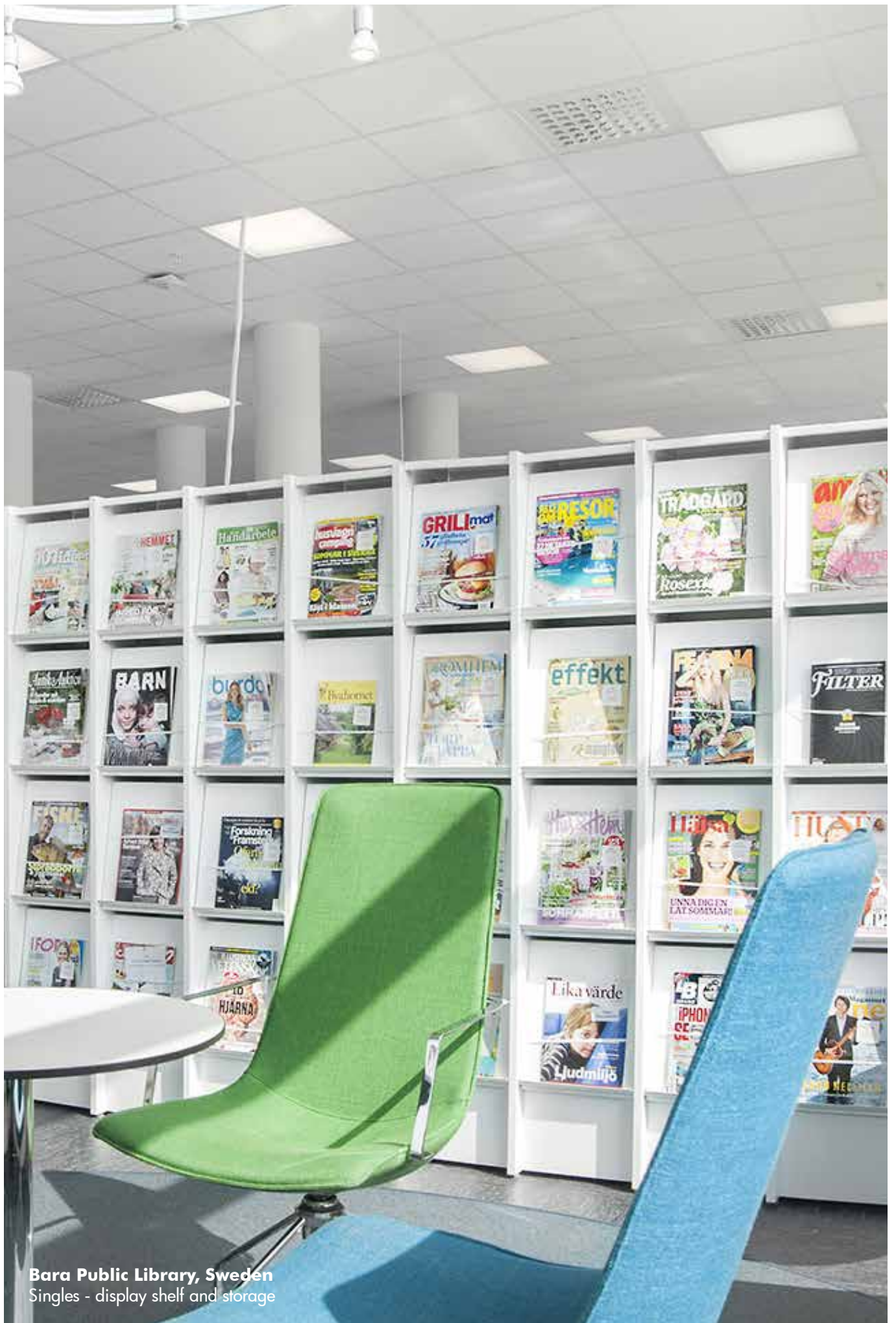

Bara Public Library, Sweden
Singles - display shelf and storage

SINGLES

Singles is a combination of wooden panels and steel shelves.

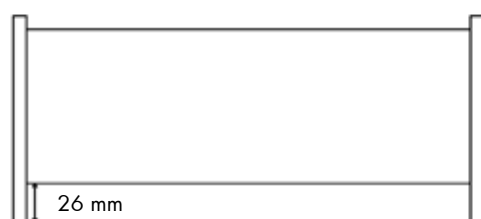

The end panels have a 4 mm flat front edge of solid wood. The plinth for height 182 cm is 21 cm and for height 212 cm is 12 cm.

Behind the steel lift-up display shelves are compartments providing space for piles of back issues.

HEIGHTS

Singles shelving comes in 2 heights; 182 and 212 cm.

Heights include adjustable feet (max. 2 cm).

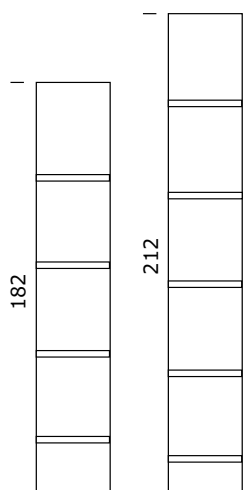

WIDTHS

The bays are available as starter and add-on bays.

A starter bay has two outside panels while an add-on bay has one intermediate panel.



DEPTHS

The panels come in 2 depths;

36 cm for 30 cm deep shelves (single-sided)

69 cm for 2 x 30 cm deep shelves (double-sided)

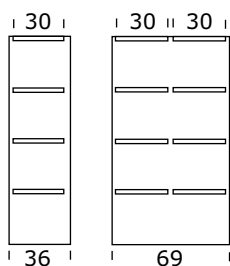

SINGLES

SINGLE-SIDED - VENEER & PAINTED

Complete shelving system with panels, full back, plinth, shelves, top shelf and fittings. The shelves are made of steel.

Height 182 cm (4 steel tip-up doors and 4 storage shelves and top shelf)

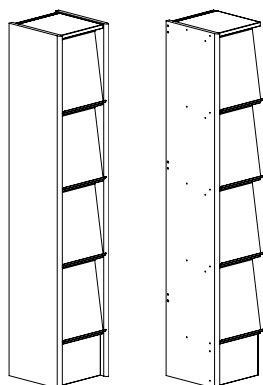

Bay	Surface	Item no.
Starter	Painted	BB782208315ZZZZZZZ4
Starter	Veneer	BB782208311ZZZZZZZ2
Add-on	Painted	BB782218315ZZZZZZZ4
Add-on	Veneer	BB782218311ZZZZZZZ2

Height 212 cm (5 tip-up doors and 5 storage shelves and top shelf)



Surface	Surface	Item no.
Starter	Painted	BB782201315ZZZZZZZ4
Starter	Veneer	BB782201311ZZZZZZZ2
Add-on	Painted	BB782211315ZZZZZZZ4
Add-on	Veneer	BB782211311ZZZZZZZ2

SINGLES

DOUBLE-SIDED - VENEER & PAINTED

Complete shelving system with panels, full back, plinth, shelves, top shelf and fittings. The shelves are made of steel.

Height 182 cm (4 tip-up doors and 4 storage shelves and top shelf on each side)

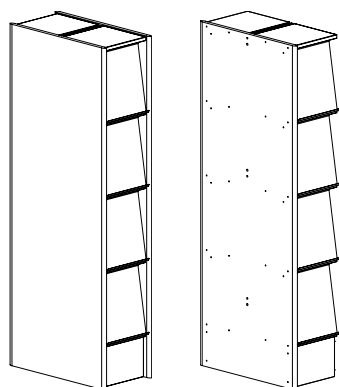

Surface	Surface	Item no.
Starter	Painted	BB782208325ZZZZZZZZ4
Starter	Veneer	BB782208321ZZZZZZZZ2
Add-on	Painted	BB782218325ZZZZZZZZ4
Add-on	Veneer	BB782218321ZZZZZZZZ2

Height 212 cm (5 tip-up doors and 5 storage shelves and top shelf on each side)

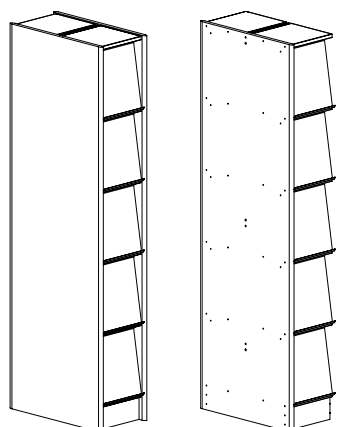

Surface	Surface	Item no.
Starter	Painted	BB782201325ZZZZZZZZ4
Starter	Veneer	BB782201321ZZZZZZZZ2
Add-on	Painted	BB782211325ZZZZZZZZ4
Add-on	Veneer	BB782211321ZZZZZZZZ2

LOCATIONS

WE ARE LIBRARY PEOPLE®



DENMARK

Lammhults Biblioteksdesign A/S
Dalbækvej 1
6670 Holsted

bci@bci.dk
www.bci.dk

FRANCE

BC Intérieur Sarl
6 allée Kepler
77420 Champs sur Marne

bci@bcinterieur.com
www.bcinterieur.com

BELGIUM

SBNL - Schulz Benelux BV
Appelweg 94 C
3221 Holsbeek

info@sbnl.be
www.sbnl.be

SWEDEN

Lammhults Biblioteksdesign AB
Odlarevägen 16
226 60 Lund

eurobib@eurobib.se
www.eurobib.se

GERMANY

Schulz Speyer Bibliothekstechnik AG
Hafenstraße 2
67346 Speyer

sales@schulzspeyer.de
www.schulzspeyer.de

UNITED KINGDOM

thedesignconcept Ltd.
The Old Bakery,
10 Greenless Road
Cambuslang Belgrave Street
Glasgow G72 8JJ

info@thedesignconcept.co.uk
www.thedesignconcept.co.uk

NORWAY

BS Eurobib AS
Alf Bjerckes Vei 20
0582 Oslo

post@bseurobib.no
www.bseurobib.no